



Operator's Manual

T-1090 SPECTRUM

Multi-Temperature Unit with Basic HMI

Revision B

Introduction

This manual is published for informational purposes only and the information furnished herein should not be considered as all-inclusive or meant to cover all contingencies. If more information is required, consult your Thermo King Service Directory for the location and telephone number of the local dealer.

Thermo King's warranty shall not apply to any equipment which has been "so installed, maintained, repaired or altered as, in the manufacturer's judgment, to affect its integrity."

Manufacturer shall have no liability to any person or entity for any personal injury, property damage or any other direct, indirect, special, or consequential damages whatsoever, arising out of the use of this manual or any information, recommendations or descriptions contained herein. The procedures described herein should only be undertaken by suitably qualified personnel. Failure to implement these procedures correctly may cause damage to the Thermo King unit or other property or personal injury.

There is nothing complicated about operating and maintaining your Thermo King unit, but a few minutes studying this manual will be time well spent.

Performing pre-trip checks and enroute inspections on a regular basis will minimize operating problems. A regular maintenance program will also help to keep your unit in top operating condition. If factory recommended procedures are followed, you will find that you have purchased the most efficient and dependable temperature control system available.

All service requirements, major and minor, should be handled by a Thermo King dealer for four very important reasons:

- They are equipped with the factory recommended tools to perform all service functions.
- They have factory trained and certified technicians.
- They have genuine Thermo King replacement parts.
- The warranty on your new unit is valid only when the repair and replacement of component parts is performed by an authorized Thermo King dealer.

Customer Satisfaction Survey

Let your voice be heard!

Your feedback will help improve our manuals. The survey is accessible through any internet-connected device with a web browser.

Scan the Quick Response (QR) code or click [Technical Publications TK Americas Feedback](#) to complete the survey.



Table of Contents

Safety Precautions	8
Danger, Warning, Caution, and Notice	8
General Practices	8
Automatic Start/Stop Operation	10
Electrical Hazard	10
Low Voltage	11
Refrigeration System Hazards	12
Refrigerant Oil Hazards	13
First Aid	13
Welding Precautions	15
Safety Nameplates	16
Unit Description	17
General Description	17
Design Features	18
Unit Options	19
Engine	20
ELC (Extended Life Coolant)	20
Clutch	21
Reciprocating Compressor	21
Basic HMI Controller	21
CYCLE-SENTRY™ Start/Stop System	21
Defrost	21
TrackKing™	22
SmartPower Electric Standby (Model 50 Units Only)	23
SmartPower Standard Features	23
SmartPower Optional Features	23

Unit Protection Devices	23
Engine Compartment Components.....	24
Unit Components.....	25

Operating Instructions for Standard HMI Control Panel.....28

Truck Standard Display HMI Control Panel	28
Display	28
Display Icons	29
Keys and LED Indicators	29
Turning the Unit On and Off.....	33
Multi-Temperature Standard Display	34
Zone Indicators	35
Automatic Zone Scrolling.....	37
Manual Zone Selection Mode	37
Turning Zones On and Off	38
Changing Zone Setpoint	40
Starting the Diesel Engine	42
Starting the Electric Motor	43
Switching from Diesel to Electric	44
Switching from Electric to Diesel	44
Selecting CYCLE-SENTRY or Continuous Mode.....	46
Selecting High Speed Lock-Out Feature	47
Initiating a Zone Manual Defrost Cycle	48
Terminating a Defrost Cycle	49
Alarms	49
Alarm Code Notification	49
Displaying Alarm Codes	50
Clearing Alarm Codes	51
Sending a Servicewatch Data Logger Start of Trip	52
Pretrip Test	53
Pretrip Test Conditions	53
Conditions Where Pretrip Tests are not Allowed	53

Pretrip Test Sequence	53
Pretrip Test Considerations	54
Performing a Pretrip Test	54
Starting a Full Pretrip Test	54
Starting an Engine Running Pretrip Test	55
Pretrip Test Results	56
Display Brightness	57
Keypad Lockout	57
Checking Truck HMI Control Panel Software Revision and Serial Number	58
Displaying Date and Time	59
Checking or Setting Date and Time Using WinTrac™	61
Setting Date and Time	62
Loading and Enroute Inspections	68
Inspecting the Load	68
Enroute Inspections	69
Specifications	71
Engine Specifications	71
Refrigeration System	72
Electrical Control System Specifications	72
Fuses	72
Electric Standby Specifications (SmartPower™ Model 50 Units)	73
Electric Motor and Overload Relay	73
Standby Power Requirements	74
Unit Maintenance	75
Maintenance Inspection Schedule	76

Remote Evaporators	76
Serial Number Locations	77
Emergency Cold Line	80
Unit Warranty	81
EPA and ARB Supplemental Emissions Warranty Statement.....	81

Safety Precautions

Danger, Warning, Caution, and Notice

Thermo King® recommends that all service be performed by a Thermo King dealer and to be aware of several general safety practices.

Safety advisories appear throughout this manual as required. Your personal safety and the proper operation of this unit depend upon the strict observance of these precautions. The four types of advisories are defined as follows:

▲ DANGER

Hazard!

Indicates an imminently hazardous situation which, if not avoided, will result in death or serious injury.

▲ WARNING

Hazard!

Indicates a potentially hazardous situation which, if not avoided, could result in death or serious injury.

▲ CAUTION

Hazard!

Indicates a potentially hazardous situation which, if not avoided, could result in minor or moderate injury and unsafe practices.

NOTICE

Hazard!

Indicates a situation that could result in equipment or property-damage only accidents.

General Practices

▲ DANGER

Risk of Injury!

Improper servicing can lead to fire, electrocution, or explosion. Never service, repair, or troubleshoot a system unless you are a professional service person.

⚠ DANGER

Hazardous Gases - Personal Protective Equipment (PPE) Required!

Refrigerant in the presence of an open flame, spark, or electrical short produces toxic gases that are severe respiratory irritants which can cause serious injury or possible death. When working with or around hazardous chemicals, ALWAYS refer to appropriate Material Data Safety Sheets (MSDS) and OSHA/GHS (Global Harmonized System of Classification and Labelling of Chemicals) guidelines for information on allowable personal exposure levels, proper respiratory protection, and handling instructions.

⚠ DANGER

Confined Space Hazards!

Avoid engine operation in confined spaces and areas or circumstances where fumes from the engine could become trapped and cause serious injury or death.

⚠ WARNING

Risk of Injury!

When using ladders to install or service refrigeration systems, always observe the ladder manufacturer's safety labels and warnings. A work platform or scaffolding is the recommended method for installations and servicing.

⚠ WARNING

Risk of Injury!

Never operate the unit unless you completely understand the controls; otherwise serious injury may occur.

⚠ CAUTION

Service Procedures!

Turn the unit off before attempting to check the engine oil.

⚠ CAUTION

Hazardous Pressures!

Do not remove expansion tank cap while coolant is hot.

Safety Precautions

⚠ CAUTION

Risk of Injury!

Avoid direct contact with hot coolant.

Automatic Start/Stop Operation

⚠ CAUTION

Risk of Injury!

The unit can start and run automatically any time the unit is turned on. Units start automatically in both Cycle Sentry mode and Continuous mode. Turn the unit On/Off switch Off and disconnect the battery before doing inspections or working on any part of the unit.

⚠ CAUTION

Risk of Injury!

Thermo King units may have options that allow for remote starting from a fully off state. Turn the unit On/Off switch Off and disconnect the battery before doing inspections or working on any part of the unit.

Electrical Hazard

⚠ DANGER

Hazardous Voltage!

When servicing or repairing a temperature control unit, the possibility of serious or even fatal injury from electrical shock exists. Extreme care must be used when working with a refrigeration unit that is connected to a source of operating power, even if the unit is not operating. Lethal voltage potentials can exist at the unit power cord, inside the control box, at the motors and within the wiring harnesses.

⚠ WARNING

Risk of Injury!

On SmartPower electric standby equipped units, always turn off the external standby power source before handling, connecting, or disconnecting the power cable. Always disconnect the standby power cord before servicing the unit.

⚠ WARNING

Hazardous Voltage!

The unit On/Off switch must be turned Off before connecting or disconnecting the standby power plug. Never attempt to stop the unit by disconnecting the power plug.

⚠ WARNING

Risk of Injury!

The unit power plug must be clean and dry before connecting it to a power source.

⚠ WARNING

Hazardous Voltage!

A certified electrician should verify that the proper standby power requirements are being supplied before connecting to a new power source.

Low Voltage

Important: *Some SR-3 components are connected directly to un-switched battery power. All connections and circuits labeled with a "2" prefix are connected directly to battery power. Always disconnect the battery before servicing the unit.*

⚠ WARNING

Live Electrical Components!

Control circuits used in refrigeration units are low voltage (12 to 48 Vdc). However, the large amount of amperage available can cause severe burns if accidentally shorted to ground with metal objects, such as tools. Do not wear jewelry, watches, or rings because they increase the risk of shorting out electrical circuits and damaging equipment or causing severe burns. If there is a risk of energized electrical contact, arc, or flash, technicians **MUST** put on all PPE in accordance with OSHA, NFPA 70E, or other local, state, or country-specific requirements for arc flash protection **PRIOR** to servicing the unit. **NEVER PERFORM ANY SWITCHING, DISCONNECTING, OR VOLTAGE TESTING WITHOUT PROPER ELECTRICAL PPE AND ARC FLASHING CLOTHING. ELECTRICAL METERS AND EQUIPMENT MUST BE PROPERLY RATED FOR INTENDED VOLTAGE.**

Refrigeration System Hazards

In the United States all technicians who maintain, service, repair, or dispose of equipment that could release refrigerants into the atmosphere must be EPA 608 certified. Thermo King recommends all service be performed by a Thermo King dealer.

⚠ DANGER

Hazardous Gases - Personal Protective Equipment (PPE) Required!

Refrigerant in the presence of an open flame, spark, or electrical short produces toxic gases that are severe respiratory irritants which can cause serious injury or possible death. When working with or around hazardous chemicals, ALWAYS refer to appropriate Material Data Safety Sheets (MSDS) and OSHA/GHS (Global Harmonized System of Classification and Labelling of Chemicals) guidelines for information on allowable personal exposure levels, proper respiratory protection, and handling instructions.

⚠ DANGER

Refrigerant Vapor Hazard!

Do not inhale refrigerant. Use caution when working with refrigerant or a refrigeration system in any confined area with a limited air supply. Refrigerant displaces air and can cause oxygen depletion, resulting in suffocation and possible death. When working with or around hazardous chemicals, ALWAYS refer to appropriate Material Data Safety Sheets (MSDS) and OSHA/GHS (Global Harmonized System of Classification and Labelling of Chemicals) guidelines for information on allowable personal exposure levels, proper respiratory protection, and handling instructions.

⚠ WARNING

Personal Protective Equipment (PPE) Required!

Refrigerant in a liquid state evaporates rapidly when exposed to the atmosphere, freezing anything it contacts. Wear butyl lined gloves and other clothing and eye wear when handling refrigerant to help prevent frostbite. When working with or around hazardous chemicals, ALWAYS refer to appropriate Material Data Safety Sheets (MSDS) and OSHA/GHS (Global Harmonized System of Classification and Labelling of Chemicals) guidelines for information on allowable personal exposure levels, proper respiratory protection, and handling instructions.

Refrigerant Oil Hazards

WARNING

Personal Protective Equipment (PPE) Required!

Protect your eyes from contact with refrigerant oil. The oil can cause serious eye injuries. Protect skin and clothing from prolonged or repeated contact with refrigerant oil. To prevent irritation, wash your hands and clothing thoroughly after handling the oil. Rubber gloves are recommended. When working with or around hazardous chemicals, ALWAYS refer to appropriate Material Data Safety Sheets (MSDS) and OSHA/GHS (Global Harmonized System of Classification and Labelling of Chemicals) guidelines for information on allowable personal exposure levels, proper respiratory protection, and handling instructions.

NOTICE

Material Damage!

Wipe up spills immediately. Refrigerant oil can damage paints and rubber materials.

First Aid

REFRIGERANT

- **Eyes:** For contact with liquid, immediately flush eyes with large amounts of water and get prompt medical attention.
- **Skin:** Flush area with large amounts of warm water. Do not apply heat. Remove contaminated clothing and shoes. Wrap burns with dry, sterile, bulky dressing to protect from infection. Get prompt medical attention. Wash contaminated clothing before reuse.
- **Inhalation:** Move victim to fresh air and use Cardio Pulmonary Resuscitation (CPR) or mouth-to-mouth resuscitation to restore breathing, if necessary. Stay with victim until emergency personnel arrive.
- **Frost Bite:** In the event of frost bite, the objectives of First Aid are to protect the frozen area from further injury, warm the affected area rapidly, and to maintain respiration.

REFRIGERANT OIL

- **Eyes:** Immediately flush with large amounts of water for at least 15 minutes. Get prompt medical attention.

Safety Precautions

- **Skin:** Remove contaminated clothing. Wash thoroughly with soap and water. Get medical attention if irritation persists.
- **Inhalation:** Move victim to fresh air and use Cardio Pulmonary Resuscitation (CPR) or mouth-to-mouth resuscitation to restore breathing, if necessary. Stay with victim until emergency personnel arrive.
- **Ingestion:** Do not induce vomiting. Immediately contact local poison control center or physician.

ENGINE COOLANT

- **Eyes:** Immediately flush with large amounts of water for at least 15 minutes. Get prompt medical attention.
- **Skin:** Remove contaminated clothing. Wash thoroughly with soap and water. Get medical attention if irritation persists.
- **Ingestion:** Do not induce vomiting. Immediately contact local poison control center or physician.

BATTERY ACID

- **Eyes:** Immediately flush with large amounts of water for at least 15 minutes. Get prompt medical attention. Wash skin with soap and water.
- **Skin:** Immediately remove contaminated clothing. Wash skin with large volumes of water, for at least 15 minutes. Wash skin with soap and water. Do not apply fatty compounds. Seek immediate medical assistance.
- **Inhalation:** Provide fresh air. Rinse mouth and nose with water. Seek immediate medical assistance.
- **Ingestion:** If the injured person is fully conscious: make the person drink extensive amounts of milk. Do not induce vomiting. Take the injured person immediately to a hospital.

ELECTRICAL SHOCK

Take IMMEDIATE action after a person has received an electrical shock. Get quick medical assistance, if possible.

The source of the shock must be quickly stopped, by either shutting off the power or removing the victim. If the power cannot be shut off, the wire should be cut with a non-conductive tool, such as a wood-handle axe or thickly insulated cable cutters. Rescuers should wear insulated gloves and safety glasses, and avoid looking at wires being cut. The ensuing flash can cause burns and blindness.

If the victim must be removed from a live circuit, pull the victim away with a non-conductive material. Use wood, rope, a belt or coat to pull or push the victim away from the current. **DO NOT TOUCH** the victim. You will receive a shock from current flowing through the victim's body. After separating the victim from power source, immediately check for signs of a pulse and respiration. If no pulse is present, start Cardio Pulmonary Resuscitation (CPR). If a pulse is present, respiration might be restored by using mouth-to-mouth resuscitation. Call for emergency medical assistance.

ASPHYXIATION

Move victim to fresh air and use Cardio Pulmonary Resuscitation (CPR) or mouth-to-mouth resuscitation to restore breathing, if necessary. Stay with victim until emergency personnel arrive.

Welding Precautions

Take precautions before electrically welding any portion of the unit or the vehicle to which it is attached. Verify that welding currents are not allowed to flow through the unit's electronic circuits.

Observe the following precautions when welding to avoid damaging electronic components.

- If the microprocessor has a power switch, turn it OFF before connecting or disconnecting the battery.
- Disconnect power to the unit.
- Disconnect all wire harnesses from the microprocessor.
- If there are any electrical circuit breakers in the control box, switch them OFF.
- Close the control box.
- Components that could be damaged by welding sparks should be removed from the unit.
- Use normal welding procedures, but keep the ground return electrode as close to the area being welded as practical. This will reduce the likelihood of stray welding currents passing through any electronic circuits.

Safety Nameplates

Observe all safety nameplates placed in various locations on the unit.

Figure 1. Proposition 65 Nameplate



Figure 2. Automatic Start Warning Nameplate



Figure 3. Caution Lifting Nameplate

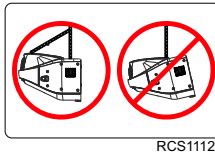

Figure 4. Caution No Grab No Step Nameplate



Figure 5. High Voltage Nameplate



Unit Description

General Description

The T-1090 SPECTRUM™ is a self-powered multi-temperature cooling and heating unit designed for straight trucks. The condensing unit is mounted on the front of the truck cargo box. The remote evaporators are located in up to three individual compartments inside the cargo box. The unit uses Chlorine free R-404A refrigerant.

The basic models provide the following:

Standard Unit (Model 30): Cooling and hot gas heating on engine operation.

SmartPower™ Unit (Model 50): Cooling and hot gas heating on engine operation and electric standby operation.

A three cylinder, EPA Tier 4, special clean and quiet diesel engine powers the unit when in the truck is in route. SmartPower (Model 50) units are also equipped with an electric motor for standby power operation while the truck is stationary.

The SR-3 microprocessor based temperature control system and in-cab HMI controller manage unit functions. CYCLE-SENTRY™, an exclusive Thermo King feature, automatically starts and stops the unit according to temperature demands. This continuous monitoring function optimizing the unit's performance and reduces fuel consumption while maintaining temperature in multiple compartments.

The on-board Pretrip unit self check feature can be run before beginning the daily distribution route to identify any possible unit malfunctions and help prevent down time.

Design Features

- Microprocessor Controlled
- Continuous System Monitoring
- In-Cab HMI Controller
- Alarm Code Display
- Battery Voltage Display
- Coolant Temperature Display
- CYCLE-SENTRY Start/Stop Controls
- Engine and Electric SmartPower (Model 50) Hour Meter
- OptiSet Plus Temperature Profiles
- Smart Defrost
- Unit Self Check-pretripping
- Aerodynamic Thermo Plastic Injection Molded Skins with In-mold Color
- Air Cleaner, Dry Type
- Alternator, 12 Volt, 37 Amp
- Bypass Oil Filter (if equipped, see SB803)
- Coolant Expansion Tank
- Economy Mode
- Fahrenheit and Celsius Display
- Fuel Filter, Spin On
- Oil Filter, Full Flow
- Serpentine Belt with Manual Tensioner
- R-404A Chlorine-free Refrigerant
- Robotic Welded Steel Frame
- X214 Compressor (T-590 and T-690)
- X430P Compressor (T890, T-1090 and T-1090 SPECTRUM)
- ETV (Electronic Throttling Valve) (T-690, T-890, T-1090 and T-1090 SPECTRUM)
- TK374F Tier 4 Diesel Engine (T-590, T-690, and T-890)
- TK380F Tier 4 Diesel Engine (T-1090 and T-1090 SPECTRUM)
- USB Diagnostic Port
- TrackKing™

Unit Options

- Body Mount HMI Enclosure
- Door Switch
- MAX Cooling System
- Electric Evaporator Heaters
- SmartPower Electric Standby (Model 50)
- SmartPower Automatic Phase Correction (Model 50)
- SmartPower Diesel/Electric Autoswitching (Model 50)
- Engine Block Heater
- Fuel Tank (30 gallon aluminum, 18" and 22")
- Quick Oil Drain Kit
- Rear Remote Control (flushmount)
- Remote Indicator Light
- Snow Cover
- Whisper™ Sound Kit
- Top Cover System
- Precision Temperature Control (except T-590 / 690)
- TouchLog
- Bluetooth
- Solar Panels
- Battery Box
- Evaporator Side Screens

Engine

Engine power for the T-1090 SPECTRUM is provided by the TK380F, a three cylinder, EPA Tier 4, special clean and quiet diesel engine rated at 19.3 continuous horsepower (14.4 kW) at 2425 RPM. A belt drive system transfers energy to the compressor and alternator.

ELC (Extended Life Coolant)

The maintenance interval for ELC is eight years or 15,000 hours. A nameplate near the coolant expansion tank identifies units with ELC. This coolant is Red instead of the previous Green or Blue-Green coolants.

Figure 6. ELC (Extended Life Coolant) Nameplate

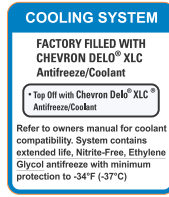

Important: Only OAT extended life coolants (Chevron Delo® XLC or equivalent) should be added to Thermo King systems. Conventional coolants should not be used (Typically identified by green or blue-green color). If a conventional coolant is combined with the Thermo King factory fill up to 25% by volume, the coolant must be changed at the next service opportunity. Above 25%, the coolant must be changed immediately. Conventional coolants dilute/interact with the additive packages of extended life coolant which significantly reduces the service life of the coolant.

Note: The use of 50/50% pre-mixed ELC is recommended to ensure that deionized water is being used. If 100% full strength concentrate is used, deionized or distilled water is recommended instead of tap water to ensure the integrity of the cooling system is maintained. The engine must have antifreeze protection to -40°F/ -40°C. Check and add coolant in the expansion tank as needed.

Clutch

The centrifugal clutch engages fully at 600 ± 100 RPM on engine operation, constantly turning the compressor, alternator, and fans at both high and low speed. The clutch isolates the engine from the belt drive system during electric standby operation on Model 50 units.

Reciprocating Compressor

The T-1090 SPECTRUM features the X430P, 4 cylinder reciprocating compressor with 30.0 cu in (492 cc) displacement.

Basic HMI Controller

The Basic HMI Controller communicates with the Base Controller (located inside the control box) and is used operate the unit and display unit information. It also provides access to all the controller functions and menus.

CYCLE-SENTRY™ Start/Stop System

The CYCLE-SENTRY Start/Stop fuel saving system provides optimum operating economy.

WARNING

Risk of Injury!

The unit can start at any time without warning. Press the OFF key on the HMI control panel, place the unit Service Switch (On/Off switch) in the Off position, and disconnect the battery before inspecting or servicing any part of the unit.

The CYCLE-SENTRY system automatically starts the unit on microprocessor demand and shuts down the unit when all demands are satisfied.

The system monitors and maintains the compartment temperature, the engine block temperature, and battery charge levels at a point where quick, easy starts are possible.

Defrost

Frost will gradually build up on the evaporator coils as a result of normal operation. Periodically this frost must be melted to prevent a loss of cooling and airflow.

Unit Description

Defrost is accomplished by passing hot refrigerant gas through the evaporator coil, thus melting the frost (or ice). Melted frost drains out of the unit onto the ground through the drain tubes.

Defrost can be initiated at any time the evaporator coil temperature is below 42 F (5.5 C).

There are two methods of defrost initiation:

SR-2/SR-3 Microprocessor Controller: The Microprocessor Controller is programmed to automatically initiate timed and forced defrost cycles. The SR-2/SR-3 uses temperature sensors to determine if forced defrost is required.

Manual Defrost: Manual Defrost allows the operator to initiate a defrost cycle by pressing the Defrost key. See "Initiating a Manual Defrost Cycle."

TrackKing™

T-90 series units are equipped with a wireless communication platform that offers fleet owners the ability to monitor their refrigerated units. Cellular, GPS, and Bluetooth capabilities communicate with Thermo King's web-based TrackKing™ application, and Bluetooth with the Thermo King Reefer App. A third party interface offers a gateway for telematics providers to communicate with the Thermo King unit. To learn more about the TrackKing features, contact your Thermo King dealer.

TrackKing Components:

- **TKV5 Module** — is located inside the controls section of the unit. The telematics module with built-in antenna allows for wireless communication with the e1000 unit. No service is required by the operator.
- **AGM battery** — is located inside the condenser section under the cooling system expansion tank. This battery is used to power the telematics system when in unit is turned off. The battery is charged when the unit is operating. and No service is required by the operator.
- **110W Solar Panel** — typically located on cargo box roof. The solar panel keeps the AGM battery charged when the unit is not in use. No service is required by the operator other then keeping the panel free of any dirt of debris.

SmartPower Electric Standby (Model 50 Units Only)

The SmartPower Electric Standby option allows the unit to be operated on either the diesel engine or external electric power.

DANGER

Hazardous Voltage!

High voltage AC power is present whenever the unit is operating in the Electric Standby mode and whenever the unit is connected to external standby power. Voltages of this magnitude can be lethal. Exercise extreme caution when working on the unit.

SmartPower Standard Features

The following features are standard equipment on units equipped with SmartPower Electric Standby.

Automatic Diesel/Electric Selection: The unit will automatically switch to electric operation when a power cord is connected and the standby power is switched On.

Overload Relay: The overload relay is self-resetting.

Hot Gas Heat: Hot gas heat is utilized on all units.

Automatic Phase Correction: The control system features two motor contactors. This allows correct motor rotation regardless of phase rotation on the incoming power.

SmartPower Optional Features

The following features are available as options on units equipped with Electric Standby.

- Auto Switching

Unit Protection Devices

High Pressure Cutout Switch (HPCO): This normally closed switch monitors the discharge pressure at the compressor. It opens on high discharge pressure to shut the unit down to prevent damage.

Electronic Throttling Valve (ETV): This component is an electromechanical control device used to limit the suction pressure to the compressor. The valve is controlled by the microprocessor controller.

Unit Description

Preheat Buzzer: The preheat buzzer sounds when the CYCLE-SENTRY system energizes the glow plugs. This should warn anyone near the unit that the CYCLE-SENTRY system is about to start the diesel engine.

Coolant Temperature Sensor: This sensor provides an engine coolant temperature input to the microprocessor. If the engine coolant temperature is too high, the controller stops the unit and records an alarm.

Electric Motor Overload Relay (Model 50): The overload relay protects the electric standby motor. The overload relay opens the circuit from the contactor to the electric motor if the motor overloads for any reason and an alarm will occur. The relay resets when the alarm code is cleared.

Fuses: Sizes and functions are described in the Specifications chapter of this manual.

Engine Compartment Components

Coolant Expansion Tank: The coolant level and temperature are monitored by the base controller. If the coolant temperature becomes too high or the level becomes too low, an alarm will occur.

CAUTION

Hazardous Pressures!

Do not remove expansion tank cap while coolant is hot.

Engine Oil Dipstick: Use the engine oil dipstick to check the engine oil level.

Receiver Tank Sight Glass: The receiver tank sight glass is used to assist in checking the amount of refrigerant in the system.

Compressor Oil Sight Glass: The compressor oil sight glass is used to check the relative level of compressor oil in the compressor sump.

Unit Components

Figure 7. Front View of Unit



RCS1207

Figure 8. Engine Compartment Components

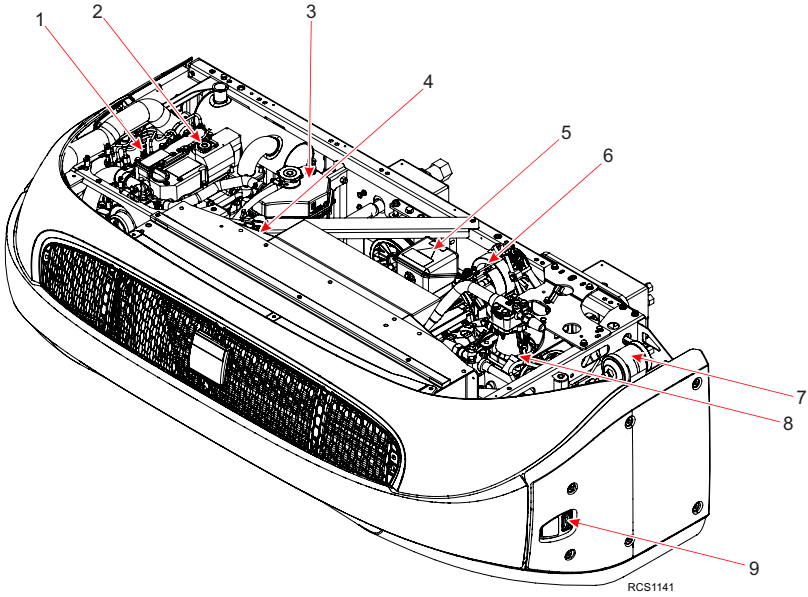

1.	Engine Oil Dipstick (on side of engine)	6.	Alternator
2.	Engine	7.	Dehydrator (Filter-Drier)
3.	Coolant Expansion Tank	8.	Compressor
4.	Coolant Overflow Bottle	9.	Base Controller On/Off Switch
5.	Electric Motor		

Figure 9. S-2 Remote Evaporator – Front View



Figure 10. S-3 Remote Evaporator – Front View



Operating Instructions for Standard HMI Control Panel

Truck Standard Display HMI Control Panel

Figure 11. Truck Standard Display HMI Control Panel



SAP357

Display

The Truck Standard Display consists of a display and nine touch-sensitive keys. The display presents information to the operator and includes setpoint and box temperature, hourmeter readings, alarms, and several icons.

The display is capable of showing numbers and illuminating several icons. It does not display text, making it suitable for use with any language.

The upper row of numbers can display the box temperature, engine run time hourmeter, current zone, or alarm code(s). The lower row of numbers can display the setpoint, electric run time hourmeter, or total number of alarms.

Figure 12. Control Panel Display

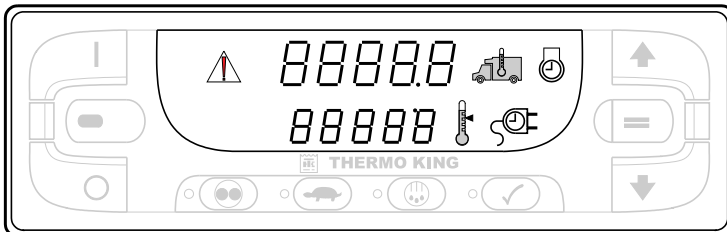

SAP359

Operating Instructions for Standard HMI Control Panel

Display Icons

Display symbols or icons are used to present additional unit information.



When this icon is present in the upper display, it is showing the actual box temperature inside the truck box.



When this icon is present in the lower display, it is showing the current setpoint.



When this icon is present in the upper display, it is showing the diesel engine run time.



When this icon is present in the lower display, it is showing the electric motor run time (if the unit is equipped with optional Electric Standby).



When this Alarm Icon is present, one or more alarm conditions have occurred. If the display is not flashing, any alarms are Check Alarms. If the display is flashing on and off, a Shutdown Alarm has occurred and the unit has been shut down. Immediate action must be taken.

Keys and LED Indicators

There are nine touch sensitive keys. Some of these keys have more than one function.

Figure 13. Keys and LED Indicators

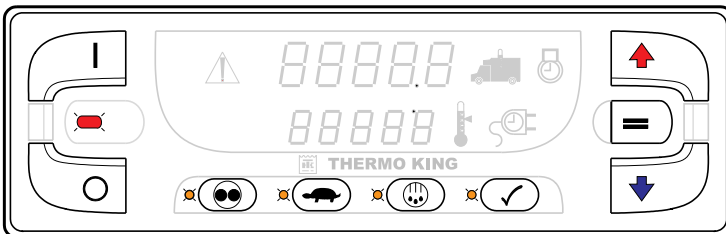

SAP365

Operating Instructions for Standard HMI Control Panel

There are amber LED indicators located next to each of the four function keys below the display. The LED will glow amber when that function is active. A red LED indicator is located between the ON Key and OFF Key at the left side of the display. This indicator will glow if Alarm Code 91 Check Electric Ready Input occurs. It will also illuminate if a 15 pin Thermo King Data Cable is connected to the serial port on the back of the Base Controller.

ON

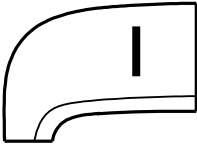

Primary Use – Pressing the ON Key will turn the unit on.

Secondary Use – When the unit is on, pressing this key and the PRETRIP Key at the same time will display any alarm codes that are present.

Secondary Use – When the unit is on, pressing and holding this key allows the UP ARROW Key and DOWN ARROW Key to increase or decrease the display brightness.

Secondary Use – When the unit is on and a different display is shown, pressing this key will return to the Standard Display of box temperature and setpoint.

Multi-Temp Use – When Manual Zone Selection is active the selected zone can be turned on and off by simultaneously pressing the ON Key and ENTER Key.

OFF

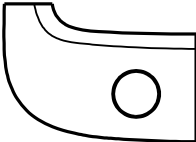

Primary Use – Pressing the OFF Key will turn the unit off.

UP ARROW

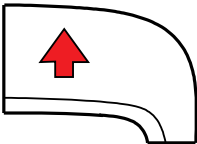

Primary Use – When the unit is turned on and the Standard Display is shown, pressing the UP ARROW Key will increase the setpoint.

Secondary Use – When alarms are being displayed, pressing this key will scroll through the alarms (if more than one alarm is present).

Secondary Use – While holding ON Key down with the unit turned on, pressing this key will increase the display brightness (Low, Medium, High).

Operating Instructions for Standard HMI Control Panel

DOWN ARROW

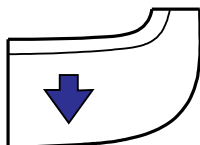

Primary Use – When the unit is turned on and the Standard Display is shown, pressing the DOWN ARROW Key will decrease the setpoint.
Secondary Use – While holding ON Key down with the unit turned on, pressing this key will decrease the display brightness (High, Medium, Low).

ENTER

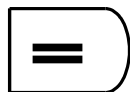

Primary Use – If the setpoint has been changed using the UP ARROW Key and/or DOWN ARROW Key, pressing the ENTER Key enters the setpoint into the base controller's memory.
Secondary Use – When alarms are being displayed, pressing this key will clear the alarm shown on the display.
Secondary Use – When the unit is turned on, press and hold this key for five seconds to send a Start of Trip (SOT) to the data logger.
Multi-Temp Use – Pressing this key will enable Manual Zone Selection mode and scroll through the installed zones, one zone at a time. When a zone is manually selected the zone can be turned on or off, the setpoint can be changed and a manual defrost cycle can be initiated if zone conditions permit.

CYCLE-SENTRY/CONTINUOUS



Primary Use – If the unit is turned on and is in Continuous Mode, pressing the CYCLE SENTRY/CONTINUOUS Key will switch operation to CYCLE SENTRY Mode and the amber LED indicator will glow. If the unit is running in CYCLE SENTRY Mode, pressing this key will switch operation to Continuous Mode and the amber LED will turn off.

HIGH SPEED LOCK-OUT



Primary Use – If the unit is turned on, pressing the HIGH SPEED LOCKOUT Key will activate High Speed Lock-Out. The unit will switch to low speed operation and the amber LED indicator will glow. No further high speed operation is allowed until this feature is turned off. If the High Speed Lockout Timer is enabled, the unit will automatically return to high speed after a programmed time limit. This feature is typically used in noise sensitive areas to reduce unit noise.

Note: *The HIGH SPEED LOCK-OUT Key is only used when the unit is operating in Diesel Mode. The HIGH SPEED LOCK-OUT Key does not have any effect in Electric Mode operation.*

Operating Instructions for Standard HMI Control Panel

DEFROST

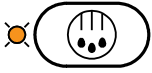

Primary Use – If the unit is turned on, pressing the DEFROST Key will initiate a manual defrost cycle if conditions allow. If the evaporator coil temperature less than 45°F (7°C) the unit will enter a defrost cycle. The amber LED will flash while the defrost cycle is initialized and will glow during the defrost cycle. The defrost cycle will terminate automatically and the amber LED will turn off when the evaporator coil temperature is greater than 52°F (11°C). To manually terminate a defrost cycle turn the unit off and back on.

Multi-Temp Use – A zone must be selected before initiating a manual defrost cycle.

PRETRIP TEST



Primary Use – Pressing and holding the PRETRIP TEST Key for five seconds will initiate either a Full Pretrip Test or Engine Running Pretrip Test so long as no alarm conditions exist. If the Alarm Icon is glowing, record and clear the alarms before starting the Pretrip Test.

Press and hold the PRETRIP TEST Key for five seconds. The amber LED may flash while the Pretrip Test is initialized and will glow steady while the Pretrip Test is running. When the Pretrip Test is complete the amber LED will turn off.

- If there are no alarm codes set when the Pretrip Test is complete, the unit passed.
- If there are alarm codes set when the Pretrip Test is complete, the unit failed. Check and correct the alarm conditions and repeat the test.
- If a shutdown alarm occurred, Alarm Code 28 Pretrip Abort will be set and the unit will be shut down. Check and correct the alarm conditions and repeat the test.

Secondary Use – When the unit is turned off press and hold this key for five seconds to show the HMI Control Panel Serial Number (in the upper display) and the HMI Control Panel Software Revision (in the lower display).

Secondary Use – When the unit is turned off this key is used to display the Clock/Calendar.

Operating Instructions for Standard HMI Control Panel

Turning the Unit On and Off

Important: Verify the Base Controller ON/OFF Switch is turned on before turning on the HMI Control Panel. The Base Controller ON/OFF switch is located on the outside of the control box side of the unit.

If the HMI Control Panel is turned on and the Base Controller ON/OFF Switch is turned off, the HMI display screen will flash ON and OFF.

The unit is turned on by pressing the ON Key and off by pressing the OFF Key. When the ON Key is pressed, the display briefly shows dashes as the display initializes.

Important: If the display flashes on and off continuously when the ON Key is pressed, check to verify the Base Controller ON/OFF switch is in the ON position.

Image Tag Expected within Figure Tag

Figure 14. Keys and LED Indicators

The unit running time hourmeters are shown for 30 seconds. The diesel engine run time hours and Diesel Icon are shown in the upper display. If the optional Electric Standby Feature is installed, the electric motor run time hours and Electric Icon appear in the lower display as shown (Figure 15, p. 33).

A Full Pretrip Test is initiated from this display by pressing and holding the Pretrip Key as shown later in this section.

Image Tag Expected within Figure Tag

Figure 15. Electric Motor Run Time Hours and Electric Icon

When the unit is ready to run, the Standard Display of box temperature and setpoint appears. The box temperature and Box Temp Icon are shown in the upper display. The setpoint and Setpoint Icon are shown in the lower display. On multi-temperature applications, the Zone indicators are shown to the left of the box temperature. In the example (Figure 16, p. 34), Zone 2 is being shown on the display.. The Zone 2 box temperature shown here is 35.8°F (2.1°C) with a 35°F (1.7°C) setpoint.

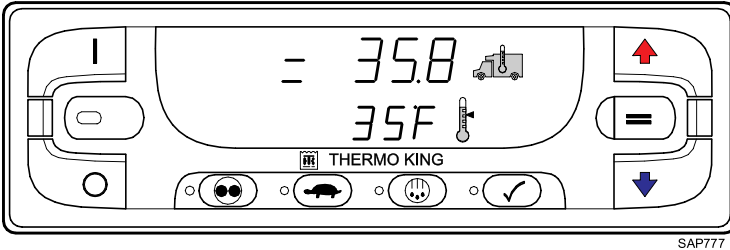
Figure 16. Zone 2

Pressing the OFF Key stops unit operation. The unit shuts down immediately and the display goes blank. To start the unit again, press the ON Key (Figure 17, p. 34).

Image Tag Expected within Figure Tag
Figure 17. ON Key

Multi-Temperature Standard Display

The Standard Display is the default display that appears if no other display function is selected. The Standard Display shows the current zone box and the temperature and setpoint of that zone.

The box temperature is that measured by the return air sensor. The box temperature and Box Temperature Icon are shown in the upper display. The setpoint and Setpoint Icon are shown in the lower display. The box temperature here is -8.2°F (-22.3°C) with a -10°F (-23.3°C) setpoint. If another display is shown, pressing the ON Key will return the display to the Standard Display.

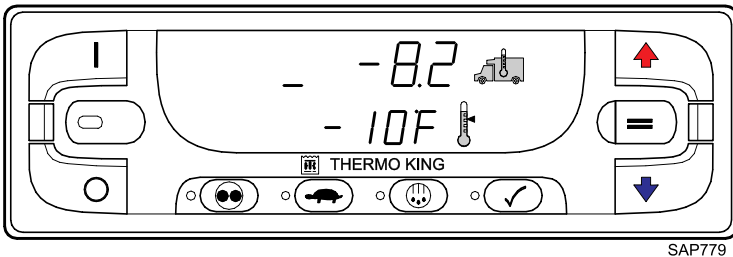
Figure 18. Truck Standard Display (TSD) HMI

Operating Instructions for Standard HMI Control Panel



Zone Indicators

Horizontal bars to the left of the box temperature are used to indicate the zone currently shown on the display. In the example (Figure 19, p. 35) Zone 3 is being shown on the display.

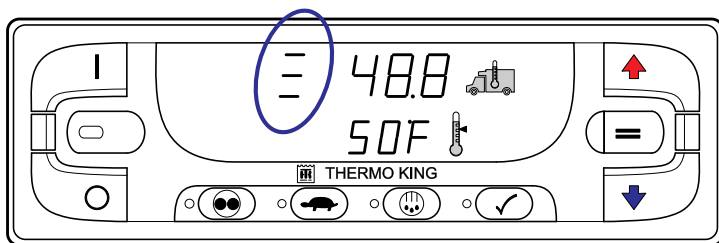
Figure 19. Zone Indicators



SAP775

	<p>When one horizontal bar is present at the left side of the box temperature, Zone 1 is being shown on the display. The display will automatically scroll through all configured zones, showing each zone for 10 seconds.</p>
	<p>When two horizontal bars are present at the left side of the box temperature, Zone 2 is being shown on the display. The display will automatically scroll through all configured zones, showing each zone for 10 seconds.</p>
	<p>When three horizontal bars are present at the left side of the box temperature, Zone 3 is being shown on the display. The display will automatically scroll through all configured zones, showing each zone for 10 seconds. Zone 3 only appears on units configured with three zones.</p>

In the example (Figure 20, p. 36), Zone 1 is being shown on the display. The box temperature in Zone 1 is -8.2°F (-22.3°C) and the setpoint is -10°F (-23.3°C).

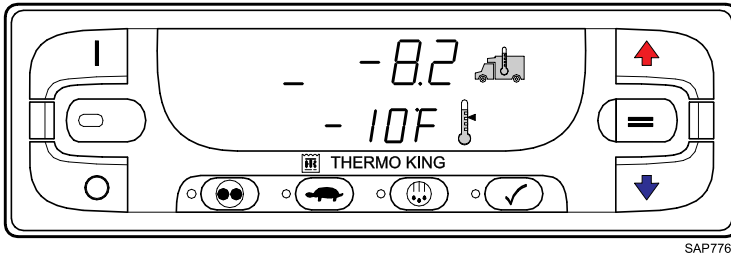
Operating Instructions for Standard HMI Control Panel**Figure 20. Zone 1**

In the example (Figure 21, p. 36), Zone 2 is being shown on the display. The box temperature in Zone 2 is 35.8°F (2.1°C) and the setpoint is 35°F (1.7°C).

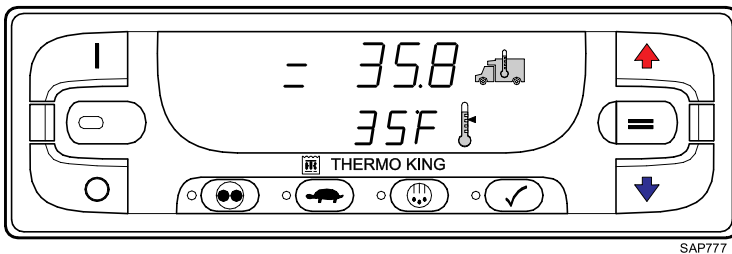
Figure 21. Zone 2

In the example (Figure 22, p. 36), Zone 3 is being shown on the display. The box temperature in Zone 3 is 48.8°F (9.3°C) and the setpoint is 50°F (10°C). Zone 3 only appears on units configured with three zones.

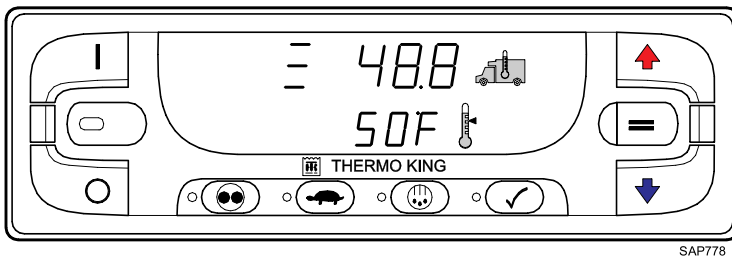
Figure 22. Zone 3

Operating Instructions for Standard HMI Control Panel

Automatic Zone Scrolling

When the Standard Display is shown, the operating conditions for each zone will automatically be shown for 10 seconds. At the end of that time, the next zone will appear on the display.

- If a zone is currently turned on, the box temperature and setpoint for that zone will be shown.

Important: *On Multi-Temperature units, Zone 1 can be turned off while the unit is running. The unit will continue to run with Zone 1 turned off.*

- If a zone is turned off, dashes will be shown instead of the box temperature and setpoint for that zone.
- If a zone is in defrost, the LED indicator next to the Defrost Key will be illuminated when that zone is shown on the display.
- Unit operating conditions are shown by the LED indicators next to the Cycle Sentry Key, High Speed Lock-out Key, and Pretrip Test Key.

In the example (Figure 23, p. 37), Zone 1 is being shown as indicated by the single horizontal bar to the left of the box temperature. The box temperature of -8.2°F (-22.3°C) and setpoint of -10°F (-23.3°C) indicate that Zone 1 is turned on. Since the Cycle Sentry LED is turned off, the unit operating in Continuous Mode. The illuminated LED next to the High Speed Lock-out Key indicates that high speed operation is locked out. The absence of the Alarm Icon indicated that no alarm conditions exist.

Figure 23. Multi-Temperature Standard Display

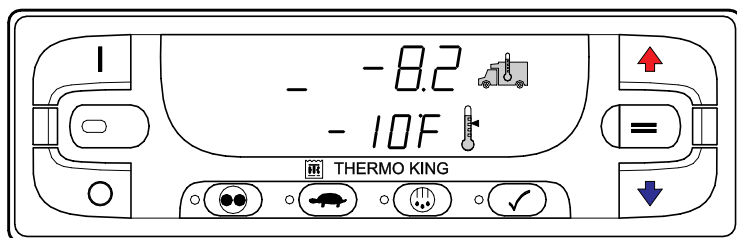

SAP779

Manual Zone Selection Mode

Manual Zone Selection mode allows the operator to select a desired zone when the Standard Display is being shown. Once a zone is selected, the zone can be turned on or off, the zone setpoint can be changed, or a manual defrost cycle can be initiated.

Operating Instructions for Standard HMI Control Panel

To manually select a zone when the Standard Display is being shown, press the Enter Key once. A decimal point will be illuminated to the right of the Zone 1 horizontal bar as shown (Figure 24, p. 38). This indicates that Manual Zone Selection MODE is active. The unit will remain in Manual Zone Selection MODE for 30 seconds after the last key press.

Figure 24. Manual Zone Selection Mode

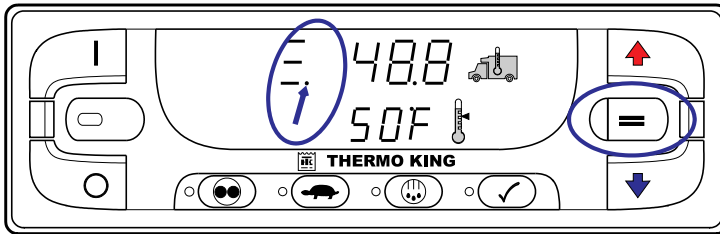

SAP783

When Manual Zone Selection MODE is active, pressing the Enter Key manually scrolls through the zones. When the desired zone is shown on the display, operation of that zone can be changed as required.

- The selected zone can be turned on or off.
- The selected zone setpoint can be changed.
- A manual defrost cycle can be initiated in the selected zone if zone conditions permit.

Turning Zones On and Off

Each configured zone can be individually turned on or off. The On and Off state for each zone is maintained even if the unit is turned off and back on. For example, if Zone 2 is turned off and the unit is then turned off and back on, Zone 2 will still be off.

Important:

1. *At least one zone must be turned on. If all configured zones but one are turned off, the controller will not allow the last zone to be turned off.*
2. *Unlike trailer applications, Zone 1 can be turned off without affecting unit operation, so long as at least one other zone is turned on.*

From the Standard Display, press the Enter Key to put the unit in Manual Zone Selection mode. Press the Enter Key again as required to select the

Operating Instructions for Standard HMI Control Panel

desired zone. In the example shown (Figure 25, p. 39), Zone 2 has been selected.

Figure 25. Zone 2

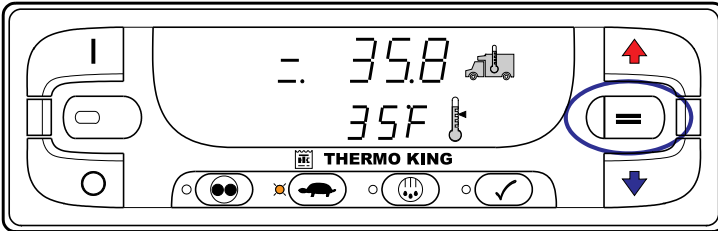

SAP784

When the desired zone is selected, simultaneously press the ON Key and ENTER Key to turn the zone off. The box temperature and setpoint show all dashes to indicate the zone is turned off as shown (Figure 26, p. 39).

Figure 26. Zone Off

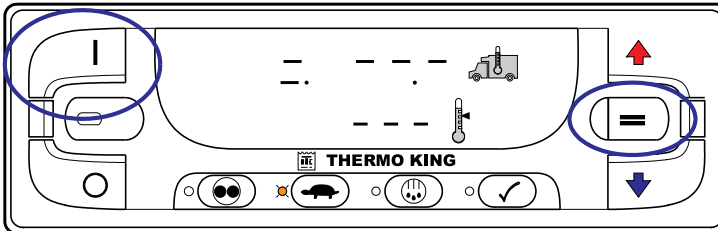

SAP785

Simultaneously pressing the ON Key and ENTER Key again will turn the selected zone back on as shown (Figure 27, p. 39).

Figure 27. Zone On

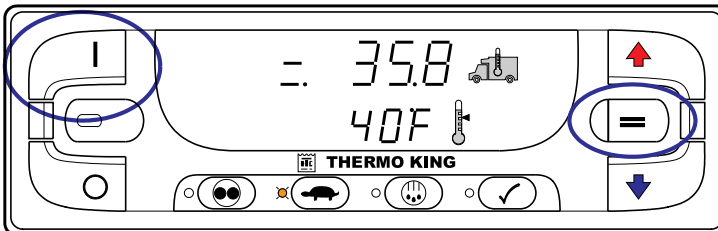

SAP786

Changing Zone Setpoint

From the Standard Display, press the Enter Key to put the unit in Manual Zone Selection mode. Press the Enter Key again as required to select the desired zone. In the example shown (Figure 28, p. 40), Zone 2 has been selected.

Figure 28. Zone 2

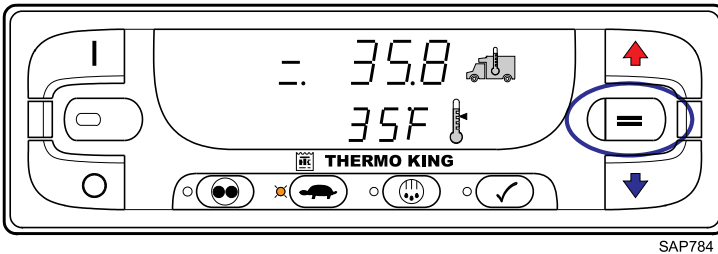

When the desired zone is selected, press the UP ARROW Key and/or DOWN ARROW Key until the desired setpoint is shown. In the example (Figure 29, p. 40), the setpoint has been increased to 40°F (4.4°C) using the UP ARROW Key.

Figure 29. Setpoint Change

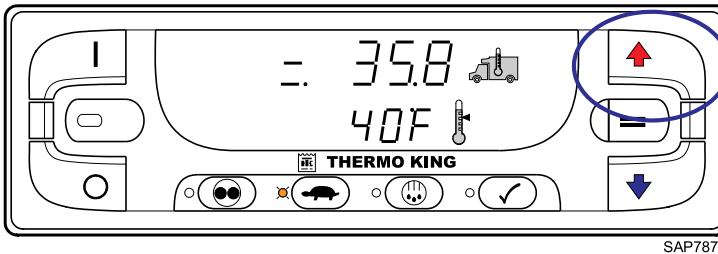

When the desired setpoint has been selected using the UP ARROW Key and DOWN ARROW Key, the ENTER Key must be pressed to confirm and load the new setpoint (Figure 30, p. 41).

Operating Instructions for Standard HMI Control Panel

Figure 30. Enter Key

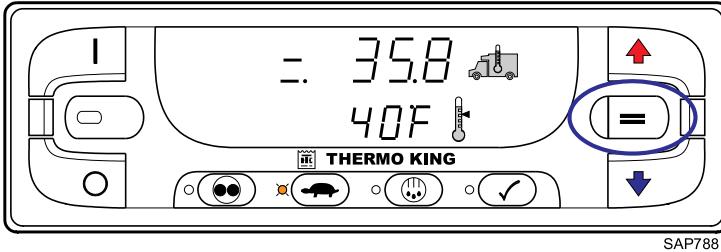

SAP788

The new setpoint of 40°F (4.4°C) will remain on the display after the ENTER Key has been pressed.

- If the setpoint is changed using the UP ARROW Key and DOWN ARROW Key, the setpoint display will begin to flash 10 seconds after the last press of the Up Arrow or Down Arrow key as a reminder to press the ENTER Key.
- The setpoint display will flash for 10 additional seconds. If at the end of this time the ENTER Key still has not been pressed to complete the setpoint change, the setpoint will return to the old setpoint and Alarm Code 127 Setpoint Not Entered will be set. The Alarm Icon will appear in the display.

Failure to confirm the new setpoint by pressing the ENTER Key within 20 seconds of changing the setpoint will result in no setpoint change. In addition, Alarm Code 127 Setpoint Not Entered is set, to indicate that the setpoint change was started but was not completed (Figure 31, p. 41).

Figure 31. Setpoint Change Not Completed

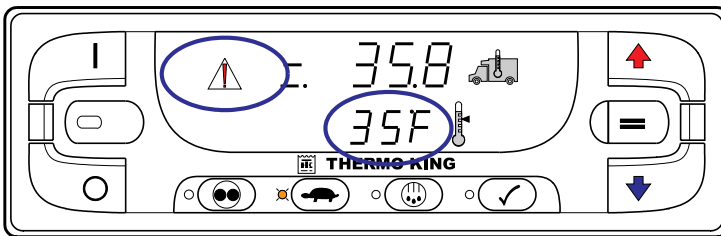

SAP789

The setpoint has returned to the old setpoint of 35°F (1.6°C) and the Alarm Icon has lighted indicating that Alarm Code 127 Setpoint Not Entered is set.

Operating Instructions for Standard HMI Control Panel

Important: *If the setpoint is changed using the UP ARROW Key or DOWN ARROW Key, the change must be confirmed by pressing the ENTER Key within 20 seconds of changing the setpoint.*

- If the ENTER Key is pressed, the setpoint change made with the UP ARROW Key and/or DOWN ARROW Key is accepted, the setpoint is changed, and the display returns to the Standard Display showing the new setpoint.
- If the ENTER Key is not pressed within 20 seconds of making a change with the UP ARROW Key and/or DOWN ARROW Key, the setpoint is not changed and the display returns to the Setpoint Display showing the old setpoint. Alarm Code 127 Setpoint Not Entered is set and the Alarm Icon will appear on the display, to indicate that the setpoint change was started but not completed.

Starting the Diesel Engine

▲ CAUTION

Risk of Injury!

The engine may start automatically any time the unit is turned on.

NOTICE

Equipment Damage!

Never use starting fluid. Damage to the engine can occur.

Verify the Base Controller On/Off switch is in the ON position. Diesel engine preheats and starts are automatic in both Continuous Mode and CYCLE-SENTRY Mode. The engine will preheat and start as required when the unit is turned on. The engine pre-heat and start sequence will be delayed in Cycle Sentry mode if there is no current need for the engine to run.

When the engine is preparing to start, the Truck Standard Display HMI Control Panel will continue to display the Standard Display as shown (Figure 32, p. 43). The preheat buzzer at the unit (located on the unit Interface Board) sounds during the engine pre-heat and crank sequence.

Note: *If the unit is equipped with optional Electric Standby, there may be some additional prompts before the engine will start. Refer to Starting The Electric Motor for details.*

Operating Instructions for Standard HMI Control Panel

Figure 32. Standard Display

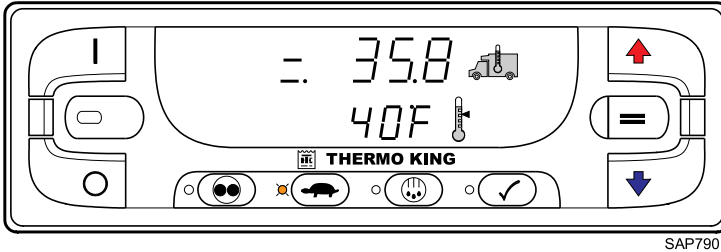

Starting the Electric Motor

Note: Units equipped with the Electric Standby option only.

⚠ CAUTION

Risk of Injury!

The motor may start automatically any time the unit is turned on.

Verify the Base Controller On/Off switch is in the ON position. Electric motor starting is automatic in both Continuous Mode and CYCLE-SENTRY Mode. The motor will start as required when the unit is turned on in Standby Mode and standby power is connected.

When the motor is preparing to start, the Truck Standard Display HMI Control Panel will continue to show the Standard Display as shown (Figure 33, p. 43). The preheat buzzer at the unit (located on the unit Interface Board) sounds for 20 seconds before the electric motor starts.

Figure 33. Standard Display

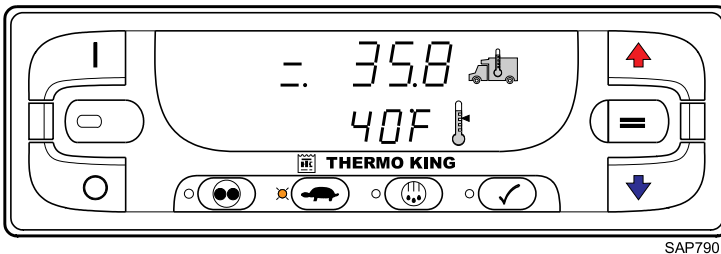

Switching from Diesel to Electric

Important: *Applies to units with the Electric Standby Option only. The operation of this feature can be changed using the Guarded Access Menu. Refer to Guarded Access / Unit Configuration Menu / Diesel to Electric Auto Switch Enabled feature in Section 3. The Diesel to Electric Auto Switch Enabled feature should be set YES on units equipped with the Truck Standard Display HMI Control Panel.*

Diesel to Electric Auto Switch Enabled set YES (Default)

If this feature is set YES, the unit will switch automatically from Diesel Mode to Electric Mode when standby power is connected and present.

Diesel to Electric Auto Switch Enabled set NO

The Diesel to Electric Auto Switch Enabled feature should not be set NO on units equipped with the Truck Standard Display HMI Control Panel.

Switching from Electric to Diesel

Important: *Applies to units with the Electric Standby Option only. The operation of this feature can be changed using the Guarded Access Menu. Refer to Guarded Access / Unit Configuration Menu / Electric to Diesel Auto Switch Enabled feature in Section 3.*

Electric to Diesel Auto Switch Enabled feature set YES

If this feature is set YES, the unit will switch automatically from Electric Mode to Diesel Mode when standby power is removed or fails.

Electric to Diesel Auto Switch Enabled feature set NO (Default)

If the unit is operating in Electric Mode and standby power is disconnected or fails, the unit will not automatically switch to Diesel mode. This is primarily designed to prevent unauthorized diesel engine starts when the truck is indoors or on a ferry where engine operation is strictly prohibited.

If the unit is operating in Electric Mode and standby power is disconnected or fails, Alarm Code 91 Check Electric Ready Input will be set. The red LED between the ON key and OFF Key will glow, the Alarm Icon will glow, and the box temperature and setpoint displays will disappear as shown ([Figure 34, p. 45](#)).

Operating Instructions for Standard HMI Control Panel

Figure 34. Alarm Icon

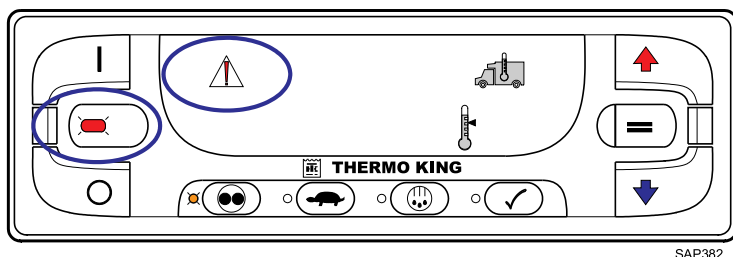

SAP382

Important:

1. If the unit is running in Electric Mode and electric standby power is lost and then restored, Alarm Code 91 Check Electric Ready Input will be automatically cleared and the unit will restart in Electric Mode.
2. When the display shown (Figure 34, p. 45) is present, do not press the Truck Standard Display HMI Control Panel OFF Key to turn the unit off. Press the HMI Control Panel ON Key twice to clear Alarm Code 91 Check Electric Ready Input and turn the unit back on in Diesel Mode.

Preferred Method for Manually Switching from Electric Mode to Diesel Mode

1. Press the HMI Control Panel OFF Key to turn the unit off.
2. Turn off the standby power and disconnect the cord.
3. Press the HMI Control Panel ON Key to turn the unit on. The Hourmeters display will briefly appear and then the screen will appear as shown.

Figure 35. Display

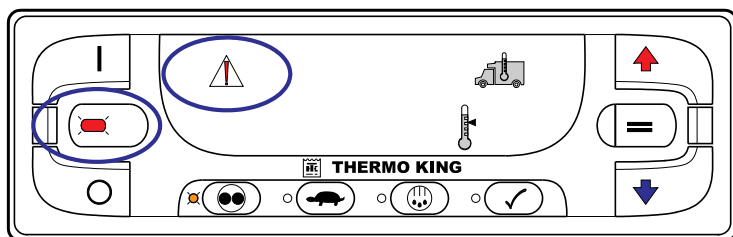

SAP382

Operating Instructions for Standard HMI Control Panel

4. Press the HMI Control Panel ON Key again to clear Alarm Code 91 Check Electric Ready Input and turn the unit back on in Diesel Mode.

Important: When the display shown (Figure 35, p. 45) is present, do not press the HMI Control Panel OFF Key to turn the unit off. Press the HMI Control Panel ON Key twice to clear Alarm Code 91 Check Electric Ready Input and turn the unit back on in Diesel Mode.

If the HMI Control Panel OFF Key is pressed when the display shown (Figure 35, p. 45) is present, the unit will turn off and the display will be blank. To restart the unit in Diesel Mode, proceed as follows:

- Press the HMI Control Panel ON Key. The Hourmeters display and a blinking Alarm Icon will appear.
- When the Hourmeters display and a blinking Alarm Icon is shown, press the HMI Control Panel ON Key again. The display will go blank but the blinking Alarm Icon will remain on and blinking.
- When the display goes blank and the blinking Alarm Icon is shown, press the HMI Control Panel ON Key again. The box temperature and setpoint will appear, the blinking Alarm Icon will disappear and the unit will start in Diesel Mode.

Selecting CYCLE-SENTRY or Continuous Mode

CAUTION

Risk of Injury!

The engine may start automatically any time the unit is turned on.

CAUTION

Risk of Injury!

If the unit is in CYCLE-SENTRY null and the mode is switched to Continuous Mode, the unit will start automatically.

When CYCLE-SENTRY mode is selected, the unit will start and stop automatically to maintain setpoint, keep the engine warm, and the battery charged. When Continuous Mode is selected, the unit starts automatically and runs continuously to maintain setpoint and to provide constant airflow.

CYCLE-SENTRY Mode or Continuous Mode is selected by pressing the CYCLE-SENTRY/CONTINUOUS Key when the unit is turned on. If the unit is running in Continuous Mode, pressing this key will switch operation to CYCLE-SENTRY Mode and the amber LED indicator will glow. If the unit is

Operating Instructions for Standard HMI Control Panel

running in CYCLE-SENTRY Mode, pressing this key will switch operation to Continuous Mode and the amber LED will turn off.

The unit shown (Figure 36, p. 47) is running in CYCLE-SENTRY Mode.

Figure 36. CYCLE-SENTRY/Continuous Key

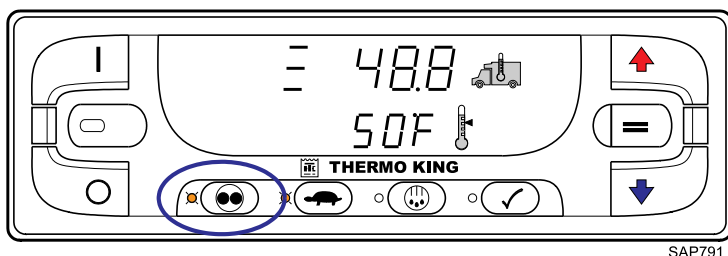

SAP791

Selecting High Speed Lock-Out Feature

If the High Speed Lock-Out feature is enabled and turned on, the unit will run only in low speed until the High Speed Lock-Out feature is turned off or the High Speed Lock-Out Timer is exceeded. This feature is typically used in noise sensitive areas to reduce unit engine noise.

High Speed Lock-Out is turned on or off by pressing the HIGH SPEED LOCK-OUT Key when the unit is turned on. Pressing this key will turn High Speed Lock-Out on; pressing it again will turn High Speed Lock-Out off. If High Speed Lock-Out is turned on, unit will switch to low speed operation and the amber LED indicator will glow. No further high speed operation is allowed until this feature is turned off or the High Speed Lock-Out Timer is exceeded.

High Speed Lock-Out Timer

If High Speed Lock-Out Mode is selected, the High Speed Inhibit Timeout feature may be enabled to return the unit to normal operation after a set time period has expired. This prevents unintended extended operation with high speed operation locked out. The time period may be set from 15 minutes to 2 hours. If a time period is set and exceeded, the unit will return to normal operation with high speed operation allowed and the amber LED indicator will turn off. If necessary to return to High Speed Lock-Out Mode, press the HIGH SPEED LOCK-OUT Key again.

The unit shown (Figure 37, p. 48) has High Speed Lock-Out turned on.

Note: The HIGH SPEED LOCK-OUT Key is only used when the unit is operating in Diesel Mode. The HIGH SPEED LOCK-OUT Key does not have any effect in Electric Mode operation.

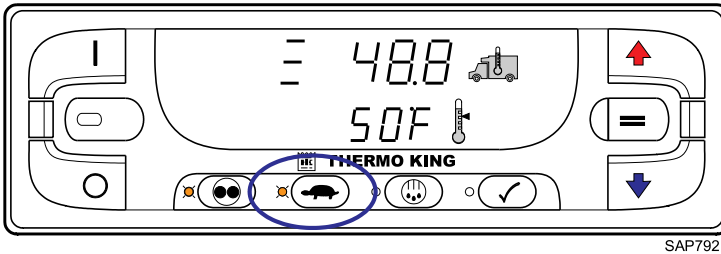
Figure 37. High Speed Lock-Out On

SAP792

Initiating a Zone Manual Defrost Cycle

Defrost cycles are usually initiated automatically based on time or demand. Manual defrost may also be available. Defrost is only available if the unit is running and the evaporator coil temperature is less than 45°F (7°C). Other features such as door switch settings may not allow manual defrost under some conditions.

From the Standard Display, press the Enter Key to put the unit in Manual Zone Selection mode. Press the Enter Key again as required to select the desired zone. In the example shown (Figure 38, p. 48), Zone 2 has been selected.

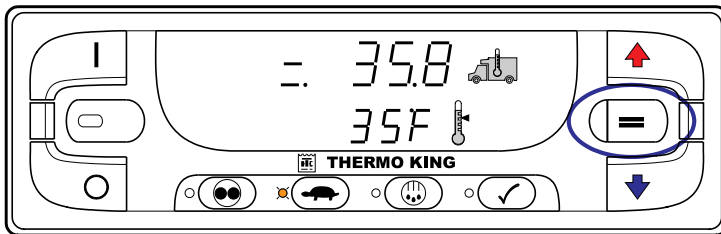
Figure 38. Zone 2

SAP784

To initiate a manual defrost cycle in the selected zone, press the DEFROST Key as shown (Figure 39, p. 49). If zone conditions allow, the zone will enter a defrost cycle and the amber LED next to the DEFROST Key will glow.

Operating Instructions for Standard HMI Control Panel

Figure 39. Defrost Key

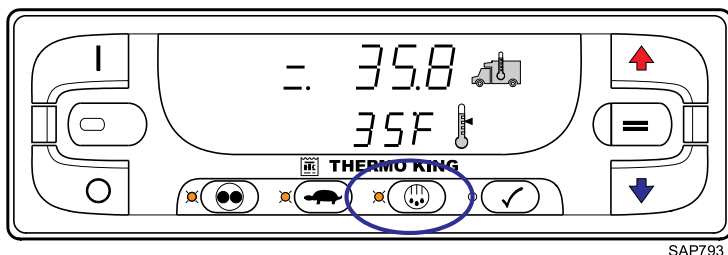

Important: During the defrost cycle, the box temperature of the zone in defrost will rise toward 50°F (10°C). This is normal and is caused by the defrost cycle warming the evaporator coil. Since the evaporator fans are turned off during the defrost cycle, this warm air is not circulated in the truck box.

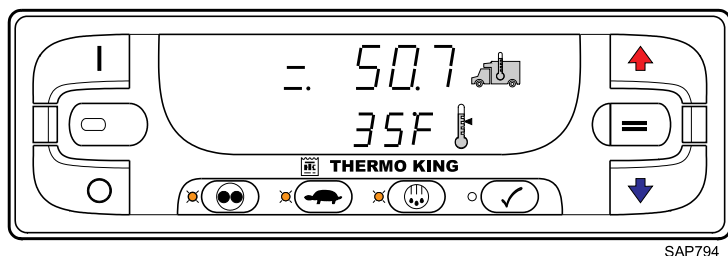

Terminating a Defrost Cycle

The defrost cycle terminates automatically when the evaporator coil temperature is greater than or equal to 52°F (11°C) or the defrost timer expires. When the defrost cycle is completed the amber LED next to the DEFROST Key will turn off. Defrost can also be terminated by turning the unit off and back on.

Alarms

Alarm Code Notification

If an alarm condition occurs, the Alarm Icon will appear on the display. If the alarm is a Check Alarm, the Alarm Icon will turn on but the unit will continue to run. If the alarm is a Shutdown Alarm, the Alarm Icon and the display will flash on and off and the unit will shut down. If the alarm is zone specific, the zone indicator will be present to show which zone has the alarm condition.

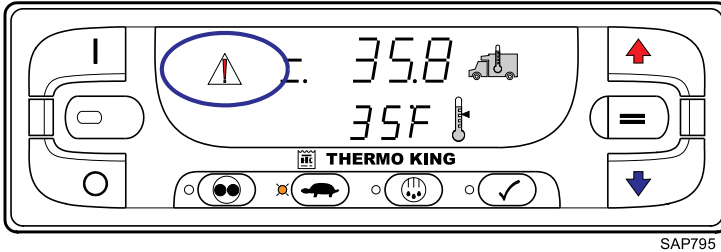
Figure 40. Alarm Icon

SAP795

Displaying Alarm Codes

Alarms are displayed by simultaneously pressing and holding the ON Key and PRETRIP TEST Key. The upper display shown (Figure 41, p. 50) indicates that Alarm Code 127 Setpoint Not Entered has been set. The lower display indicates that only one alarm code exists. If more than one alarm code has been set, they are displayed with the most recent alarm shown first. Use the UP ARROW Key to scroll through the alarms.

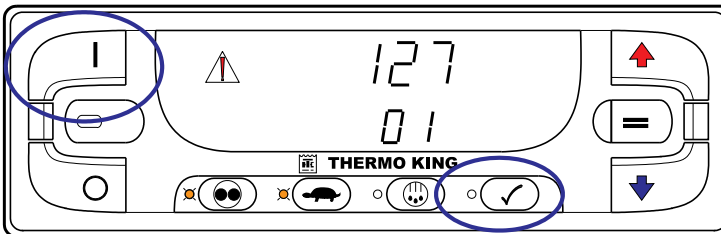
Figure 41. ON and PRETRIP TEST Keys

SAP391

Unit Alarm Codes

Unit alarms affect the operation of the entire unit. The Alarm Display shown above indicates that Alarm Code 127 exists and that there is only one alarm condition present.

Zone Specific Alarm Codes

If an alarm condition is specific to a zone, the zone indicator will be present to identify the zone experiencing the alarm condition. The Alarm Display shown (Figure 42, p. 51) indicates that Alarm Code 127 Setpoint Not Entered exists in Zone 2. It also shows that a total of three alarm conditions exist.

Operating Instructions for Standard HMI Control Panel

Figure 42. Zone Specific Alarm Display

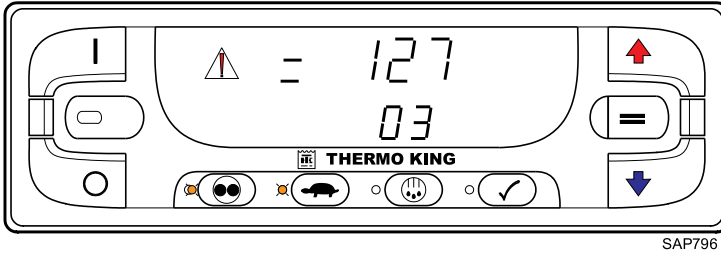

Multiple Alarm Codes

If more than one alarm code has been set, they are displayed with the most recent alarm shown first. Use the UP ARROW Key to scroll through the alarms.

Clearing Alarm Codes

After the alarm situation is resolved, press the ENTER Key to clear the alarm code currently being shown. When all alarms have been cleared, the display will show all zeros to indicate that no alarm codes exist.

Figure 43. ENTER Key

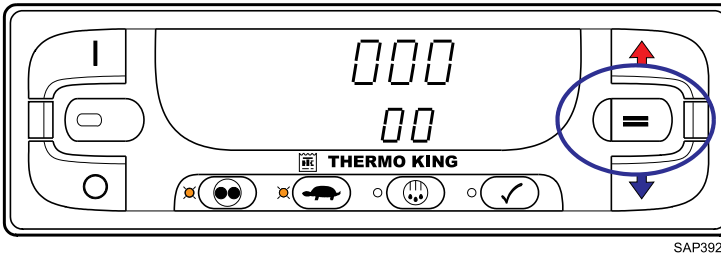

The display will return to the Standard Display about 30 seconds after all alarms have been cleared.

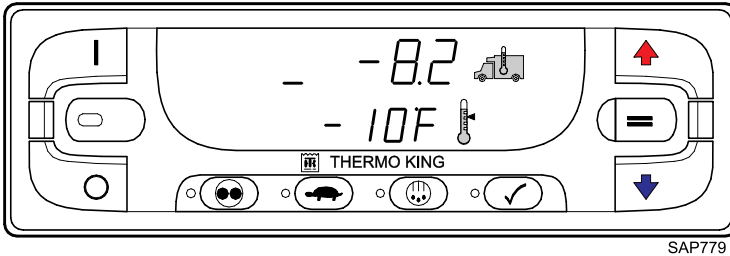
Figure 44. Standard Display

Important Alarm Notes

- All alarms must be viewed before any of the alarms can be cleared.
- If an alarm will not clear, it may still exist. If the alarm is not corrected, it will not clear or may be immediately set again.
- Some alarms cannot be cleared using the HMI Control Panel. These alarms must be cleared by maintenance personnel from the Maintenance or Guarded Access Menu.
- Alarm Code 91 Check Electric Ready Input is cleared by turning the unit off and back on. Refer to Switching From Electric To Diesel in this section.

Sending a Servicewatch Data Logger Start of Trip

When the unit is turned on, press and hold the ENTER Key for five seconds to send a Start of Trip (SOT) marker to the unit ServiceWatch Data Logger and the optional DAS Data Logger (if equipped).

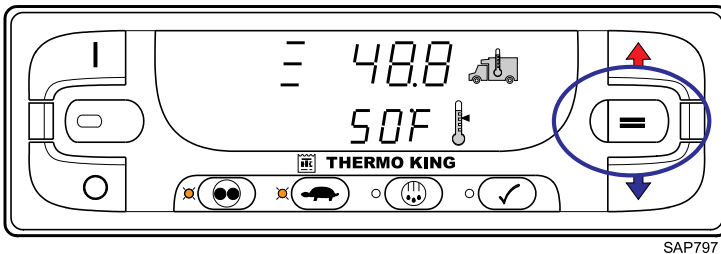
Figure 45. ENTER Key

Operating Instructions for Standard HMI Control Panel

Pretrip Test

A Pretrip Test verifies unit operation. The PRETRIP Key allows either a Full Pretrip Test or an Engine Running Pretrip Test to be initiated by the operator.

Pretrip Test Conditions

- The current unit settings are saved and restored at the end of the Pretrip Test or if the unit is turned off and back on.
- The Pretrip Test can be run in either Diesel or Electric Mode.
- The unit will auto switch from Diesel Mode to Electric Mode or from Electric Mode to Diesel Mode during a Pretrip Test if these features are enabled and the auto switch conditions occur.

Conditions Where Pretrip Tests are not Allowed

- Pretrip Tests are not allowed if any Shutdown Alarms are present.
- Pretrip tests are allowed with some Check and Log Alarms present.

Pretrip Test Sequence

Pretrip tests proceed in the order shown below. A Full Pretrip Test is started with the engine or motor not running and includes all tests. A Running Pretrip Test is started with the engine or motor running and does not include the Amp Checks or Engine Start Check.

- Amp Checks - Each electrical control component is energized and the current drawn is confirmed as within specification.
- Engine Start - The engine will start automatically.
- Defrost - If the coil temperature in a zone is below 45°F (7°C), a defrost cycle is initiated for that zone.
- RPM Check - The engine RPM in high and low speed is checked.
- Zone 1, 2, or 3 Cool Check - The ability of the zone to cool in low speed is checked.
- Zone 1, 2, or 3 Heat Check - The ability of the zone to heat in low speed is checked.
- Zone 1, 2, or 3 Return to Cool Check - The ability of the zone to return to cool mode is checked.
- Report Test Results - The test results are reported as PASS, CHECK, or FAIL when the Pretrip Test is completed. If test results are CHECK or FAIL, alarm codes will exist to direct the technician to the source of the problem.

Operating Instructions for Standard HMI Control Panel

Pretrip Test Considerations

Important: Always perform Pretrip with the dividing wall(s) in place.

Running a Pretrip with the dividing wall(s) removed may result in false test results.

When performing a Pretrip Test, the following issues should be considered.

- Whenever possible, run the Pretrip Test with an empty truck box.
- If running a Pretrip Test on a truck loaded with dry cargo, verify that proper airflow can occur around the load. If the load restricts airflow, false test results may occur. Units have high refrigeration capacity which results in rapid temperature change. Sensitive dry cargo may be damaged as a result.
- If running a Pretrip Test on a truck that has just been washed down, the extremely high humidity inside the truck box may result in false test results.
- If running a Pretrip Test on a truck loaded with sensitive cargo, monitor the load temperature during the test as normal temperature control is suspended during pre-trip operation.
- Always perform Pretrip Tests with the cargo doors closed to prevent false test results.

Performing a Pretrip Test

Starting a Full Pretrip Test

The Full Pretrip Test must be started with the unit not running. Turn the unit on and clear all alarm codes. Turn the unit off.

Turn the unit on and wait for the unit running time hourmeters to be shown on the display. When the unit running time hourmeters are shown, press and hold the PRETRIP Key for five seconds (Figure 46, p. 55).

- A flashing Pretrip LED indicates that the Pretrip Test is being initialized. When the Pretrip Test starts, the Pretrip LED will glow steady amber. The display will show the Standard Display.
- The Amps Check Test will be performed and then the unit will start automatically. The balance of the tests will be completed.
- The Pretrip Test will take about 20 - 30 minutes, depending on conditions.

Important: *The box temperature will vary during the Pretrip Test. This is normal operation.*

- When the Pretrip Test is complete or if a Shutdown Alarm occurs, the amber Pretrip LED will turn off.

Operating Instructions for Standard HMI Control Panel

To stop a Pretrip Test at any time, press the POWER OFF Key to turn the unit off. This will generate Alarm Code 28 Pretrip Abort. Other alarm codes may also be generated. This is normal when the Pretrip Test is halted before completion.

Figure 46. PRETRIP Key

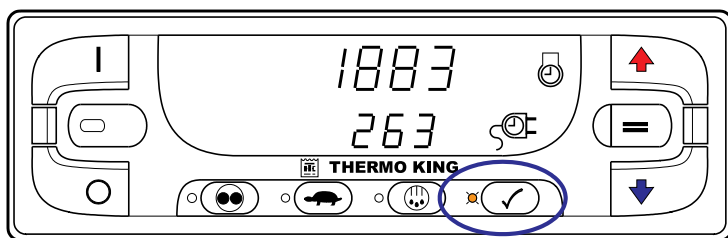

SAP798

Starting an Engine Running Pretrip Test

The Engine Running Pretrip Test must be started with the unit running. Turn the unit on and clear all alarm codes. Allow the unit to start.

With the unit running, press and hold the PRETRIP Key for five seconds (Figure 47, p. 56).

- A flashing Pretrip LED indicates that the Pretrip Test is being initialized. When the Pretrip Test starts, the Pretrip LED will glow steady amber to indicate the test is in progress. The display will show the Standard Display.
- The Pretrip Test will take about 20 - 25 minutes, depending on conditions.
Important: *The box temperature will vary during the Pretrip Test. This is normal operation.*
- When the Pretrip Test is complete or if a Shutdown Alarm occurs, the amber Pretrip LED will turn off.

To stop a Pretrip Test at any time, press the POWER OFF Key to turn the unit off. This will generate Alarm Code 28 Pretrip Abort. Other alarm codes may also be generated. This is normal when the Pretrip Test is halted before completion.

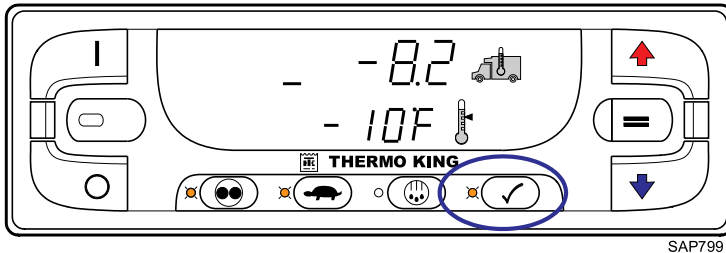
Figure 47. PRETRIP Key

SAP799

Pretrip Test Results

Pass Pretrip Test

- If the unit passes the Pretrip Test, the amber Pretrip Test LED will turn off at the completion of the test and the unit will continue to run as required. This signifies that the unit passed the Pretrip Test.

Fail Pretrip Test with Check Alarms

- If the unit fails the Pretrip Test with Check alarms, the Alarm Icon will appear when the alarm condition occurs. The Pretrip Test will continue to run unless a Shutdown Alarm occurs.
- The amber Pretrip Test LED will turn off at the completion of the test, but the Alarm Icon will remain lit. This indicates that one or more Check Alarm conditions occurred during the Pretrip Test. More than one alarm may be present.
- View and record the alarm(s), correct as necessary, clear the alarm(s) and repeat the Pretrip Test.

Fail Pretrip Test with Shutdown Alarms

- If the unit fails the Pretrip Test with a Shutdown alarm, the Alarm Icon will appear when the alarm condition occurs, the unit will immediately shut down and the amber Pretrip Test LED will turn off.
- The Pretrip Test will be aborted.
- Alarm Code 28 Pretrip Abort will be set along with the Shutdown Alarm that was detected. This signifies that a Shutdown Alarm occurred during the Pretrip Test and that the test was aborted. Other alarms may also be present.
- View and record the alarm(s), correct as necessary, clear the alarm(s) and repeat the Pretrip Test.

Operating Instructions for Standard HMI Control Panel

Display Brightness

The brightness of the HMI Control Panel display can be adjusted to allow for changing ambient light conditions. The choices available to the operator are HIGH, MEDIUM, and LOW.

To change the display brightness, press and hold the ON key and press the UP ARROW Key to increase display brightness and the DOWN ARROW Key to decrease display brightness.

Figure 48. ON Key, UP/DOWN Arrow Keys

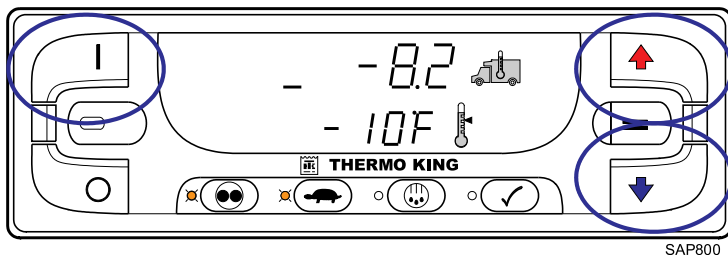

Keypad Lockout

The Keypad Lockout feature allows the operator to lock the keypad to prevent tampering. If the Keypad Lockout feature is turned on, all keys except the ON Key and OFF Key are prevented from functioning. The unit can still be turned On and Off, but doing so does not clear Keypad Lockout.

To turn Keypad Lockout on, simultaneously press and hold the ON Key, CYCLE SENTRY Key, and HIGH SPEED LOCK-OUT Key for five seconds. The display shown (Figure 49, p. 57) will appear, with [0 - - - n] replacing the box temperature. When the three keys are released, the display will return to the Standard Display of box temperature and setpoint.

Figure 49. ON Key, CYCLE SENTRY Key, and HIGH SPEED LOCK-OUT Key

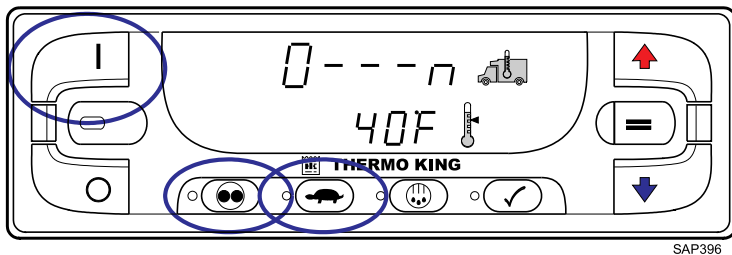

Operating Instructions for Standard HMI Control Panel

When Keypad Lockout is turned on, only the ON and OFF Keys are functional. All other keys are locked out. Pressing any key other than the ON Key and OFF Key will cause the box temperature to display [0 - - n]. When the key is released, the display will return to the Standard Display of box temperature and setpoint.

To turn Keypad Lockout off, simultaneously press and hold the ON Key, CYCLE SENTRY Key, and HIGH SPEED LOCK-OUT Key for five seconds. The display shown (Figure 49, p. 57) will appear, with [0 - - n] replacing the box temperature. When the three keys are released, the display will return to the Standard Display of box temperature and setpoint. All keys will function normally.

Checking Truck HMI Control Panel Software Revision and Serial Number

The HMI Control Panel serial number and software revision can be displayed if necessary. To display the serial number and software revision, press and hold the PRETRIP key for five seconds when the unit is turned off.

Figure 50. PRETRIP Key

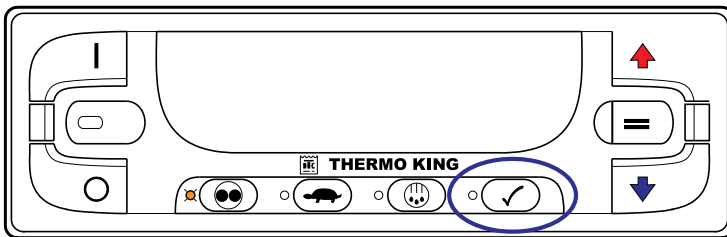

SAP399

The serial number is shown at the top of the display and the software revision is shown at the bottom of the display. The HMI Control Panel Serial Number shown (Figure 51, p. 59) is 00212. The software revision shown is Revision 2204.

Operating Instructions for Standard HMI Control Panel

Figure 51. Software Revision and Serial Number

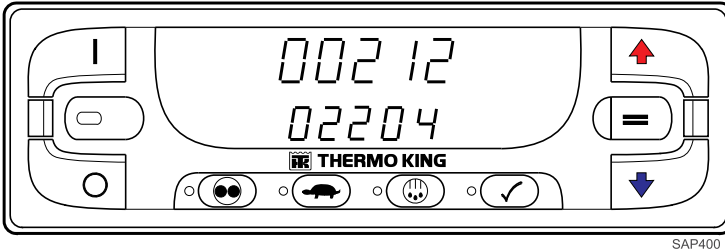

Displaying Date and Time

The Date and Time can be viewed and changed using the HMI Control Panel equipped with Software Revision 2204 and later. To display the Date and Time, press, off, and hold the PRETRIP key for five seconds when the unit is turned off.

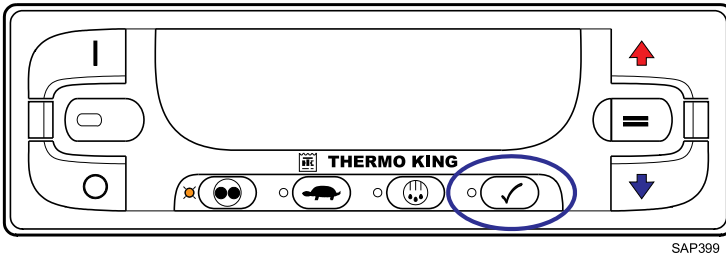

The HMI Control Panel serial number will be shown at the top of the display and the installed software revision will be shown at the bottom of the display.

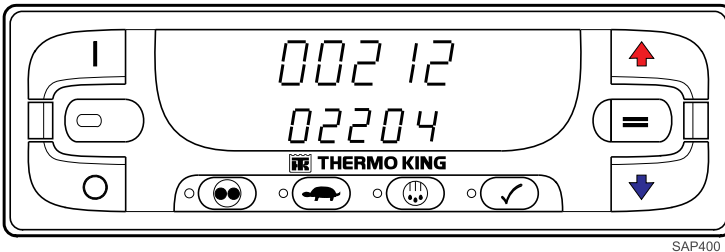

Operating Instructions for Standard HMI Control Panel

Press the PRETRIP key again to display the current date and time as held by the HMI Control Panel. The time shown is 8:33 AM and the date is January 27th.

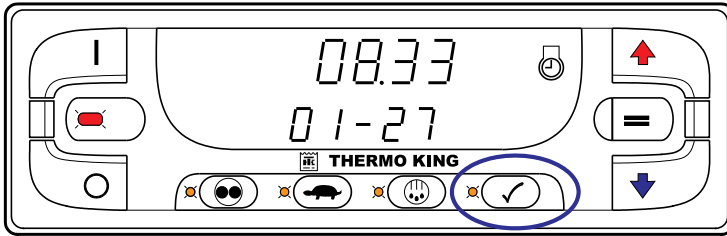

Time Display

The time displayed by the HMI Control Panel is always shown by means of a 24 hour clock. This time is sometimes referred to as military time or 24 hour time. Refer to the table (Table 1, p. 60) to convert 24 hour time to 12 hour time.

Table 1. Time Conversion

Morning		Afternoon - Evening	
12 Hour	24 Hour	12 Hour	24 Hour
Midnight	0000	Noon	1200
1 AM	0100	1 PM	1300
2 AM	0200	2 PM	1400
3 AM	0300	3 PM	1500
4 AM	0400	4 PM	1600
5 AM	0500	5 PM	1700
6 AM	0600	6 PM	1800
7 AM	0700	7 PM	1900
8 AM	0800	8 PM	2000
9 AM	0900	9 PM	2100
10 AM	1000	10 PM	2200
11 AM	1100	11 PM	2300
12 AM	1200	12 PM	2400

Operating Instructions for Standard HMI Control Panel

Date Display

Dates can be displayed in one of two ways.

- If the US/EU Clock Set Feature is set for US, time is displayed as Month - Day (December 10, 2012).
- If the US/EU Clock Set Feature is set for EU, time is displayed as Day - Month (10 December, 2012).

Checking or Setting Date and Time Using WinTrac™

Date and Time can be checked and changed using WinTrac 5.2 or later. Power must be connected to the Truck Standard Display and the unit must be turned off in order to check or change the Date and Time.

1. Remove the Truck Standard Display as necessary to gain access to the back of the device.
2. Turn the unit on to verify that power is available to the Truck Standard Display. Turn the unit back off.
3. Remove the back cover from the Truck Standard Display.
4. Connect a Thermo King 9 to 15 pin serial cable from a computer to the 15 pin connector on the back of the Truck Standard Display as shown below.

Figure 52. 15 Pin D Connector

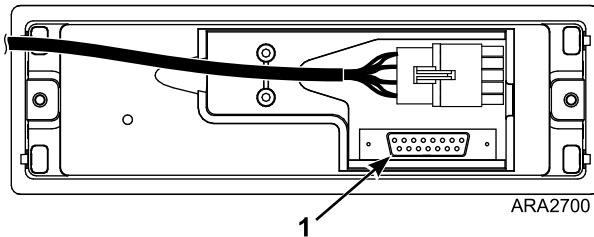

1.	15 Pin "D" Connector
----	----------------------

5. When the cable is connected, verify the red LED indicator located between the Truck Standard Display POWER ON Key and POWER OFF Key is illuminated as shown (). If the red LED indicator is not illuminated, the Date and Time cannot be changed. If the red LED indicator is not illuminated, verify the unit is turned off.

Operating Instructions for Standard HMI Control Panel

Figure 53. Red LED Indicator

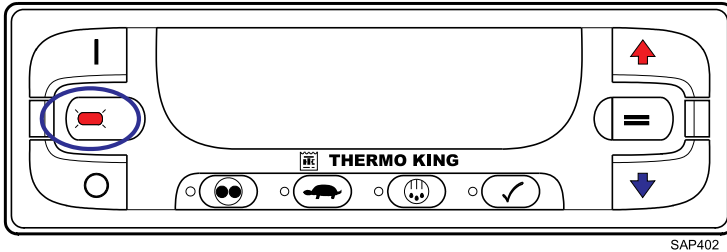

6. Open WinTrac 5.2 or later. Earlier versions of WinTrac will not work.
7. Select Seek Device.
8. Use WinTrac to set the Date and Time. Refer to the WinTrac Help File for additional information.
9. When the Date and Time is set and checked, disconnected the cable, replace the back cover, and reinstall the Truck Standard Display as required.
10. Turn the unit on and perform a ServiceWatch Data Logger download using WinTrac to verify the Date and Time are correct.

Setting Date and Time

The Date and Time can be changed using the HMI Control Panel with Software Revision 2204 and later. Display the current Date and Time as shown on the previous pages.

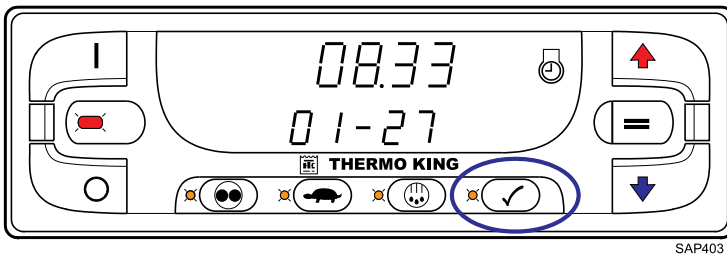

When the current Date and Time is shown on the display, press and hold the Enter key to display US - EU.

Operating Instructions for Standard HMI Control Panel



SAP404

Using the Up Arrow Key and/or Down Arrow Key, select the flashing display to either "US" or "EU" as desired.

- If the US/EU Clock Set Feature is set for "US", time is displayed as Month - Day (December 10, 2012).
- If the US/EU Clock Set Feature is set for "EU", time is displayed as Day - Month (10 December, 2012).

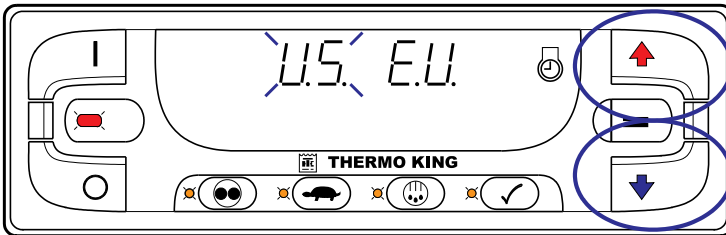

SAP405

Press the Enter key to display the year. The year will flash indicating it can be changed.

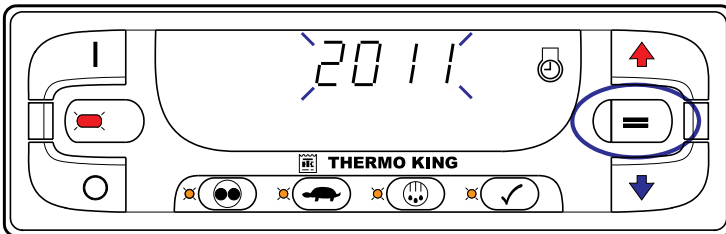

SAP406

Using the Up Arrow Key and/or Down Arrow Key, select the current year.

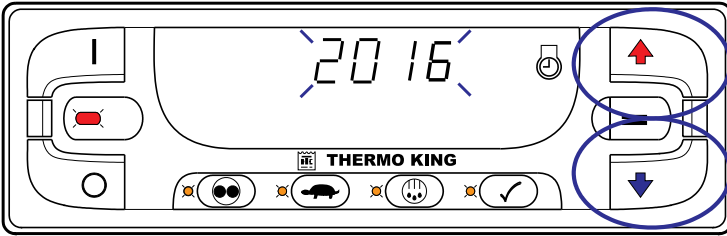
Operating Instructions for Standard HMI Control Panel

Press the Enter key to display the Month - Day. The Month will flash indicating it can be changed.

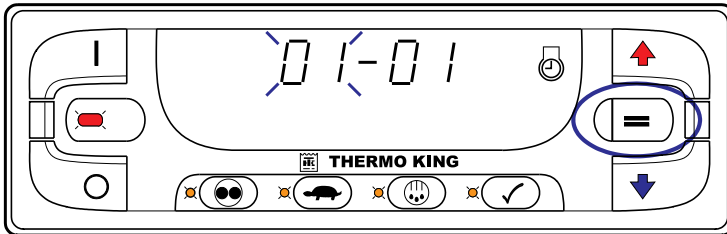

Using the Up Arrow Key and/or Down Arrow Key, select the current month.

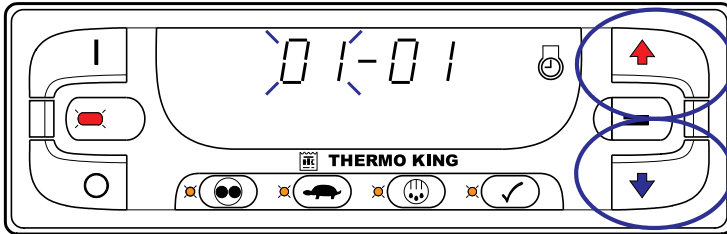

Press the Enter key to display the Month - Day. The Day will flash indicating it can be changed.

Operating Instructions for Standard HMI Control Panel

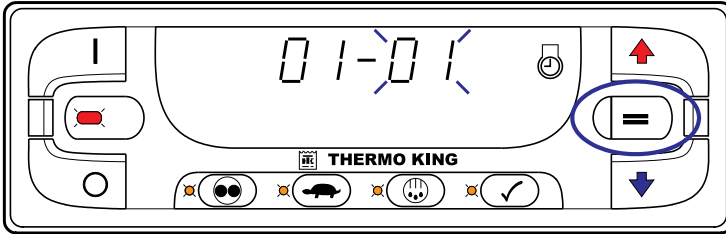

SAP410

Using the Up Arrow Key and/or Down Arrow Key, select the current day.

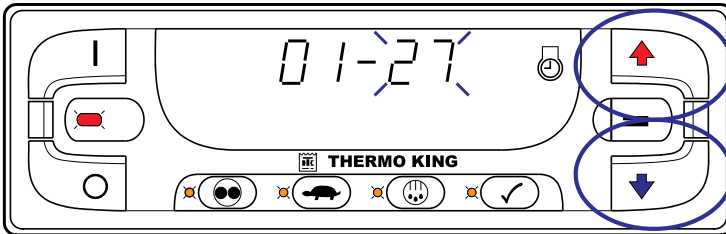

SAP411

Press the Enter key to display the Time. The Hour setting will flash indicating it can be changed. The hours shown in 24 Hour clock format are "14", which is the same as 2 PM.

Note: Hours are displayed on a 24 Hour Clock as shown under Checking Date and Time.

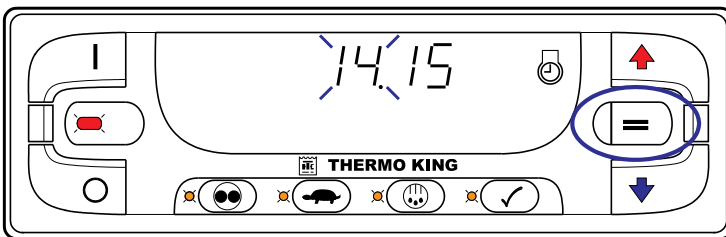

SAP412

Using the Up Arrow Key and/or Down Arrow Key, select the desired Hour. The hours shown is now 8 AM.

Note: Hours are displayed on a 24 Hour Clock as shown under Checking Date and Time.

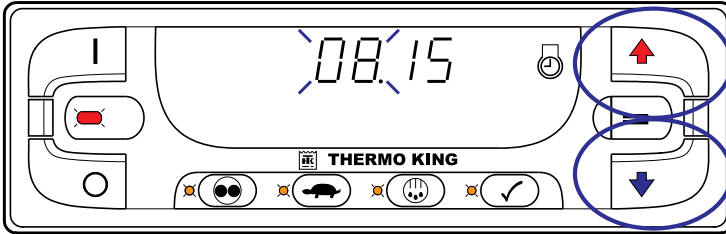
Operating Instructions for Standard HMI Control Panel

SAP413

Press the Enter key to display Minutes. The Minute setting will flash indicating it can be changed. The minutes shown are 15 minutes past the hour.

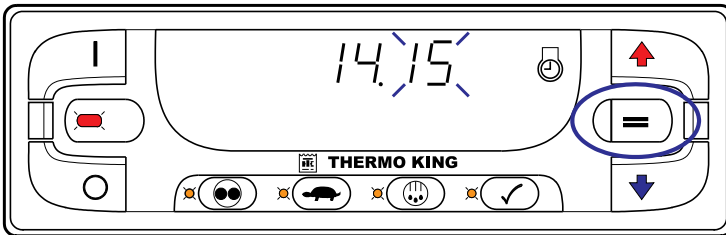

SAP414

Using the Up Arrow Key and/or Down Arrow Key, select the desired Minutes. The minutes shown are now 33 minutes past the hour.

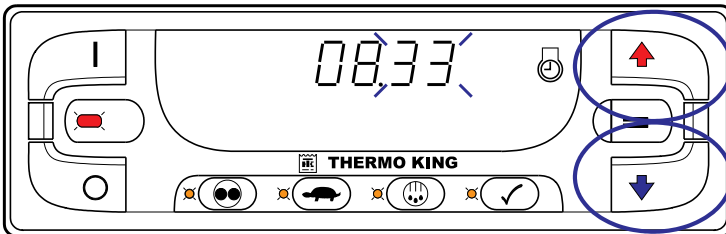

SAP415

Press the Enter Key to load the Date and Time. The time shown is 8:33 AM and date is January 27th.

Important: The Enter Key must be pressed to complete the Date and Time change.

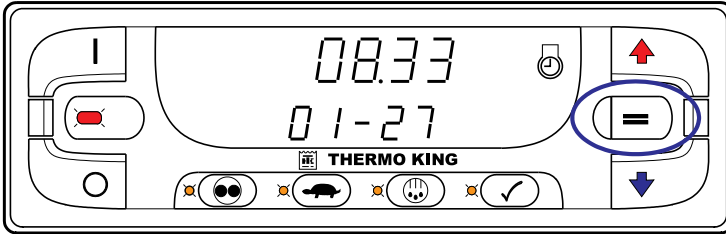
Operating Instructions for Standard HMI Control Panel

SAP416

To leave the Date and Time Display press the Off Key. The displays will also time out after one minute.

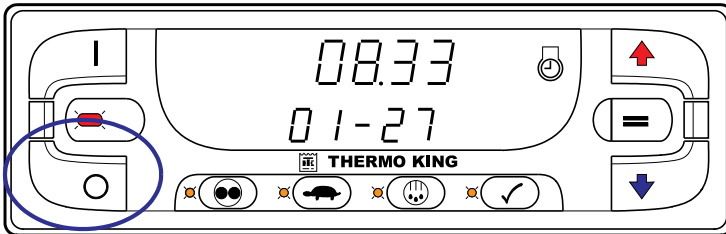

SAP417

Verify the Date and Time is correct displaying the current date and time as shown under Displaying Date and Time. Date and time can also be checked using WinTrac 5.3 or later.

Loading and Enroute Inspections

Important: Make sure cargo is pre-cooled to the proper temperature before loading. The Thermo King unit is designed to maintain temperature, not cool an above-temperature load.

1.	Inspect unit condenser grille openings to ensure they are free of debris.
2.	Inspect evaporator defrost drains to ensure they are not plugged or kinked.
3.	Confirm there is sufficient fuel in tank to operate unit for time required for deliveries.
4.	Maintain a minimum of 1219 mm (48 in.) between evaporator air outlets and wall or bulkhead.
5.	Inspect cargo box compartment inside and out for: <ul style="list-style-type: none"> Inspect condition of door seals. They must seal tightly with no air leakage. Damaged walls, missing insulation or blocked floor channels. Inspect bulkheads (if applicable) for a air tight fit at ceiling, walls, and floor.
6.	Using the HMI Controller, turn the unit on to pre-cool cargo compartment: <ul style="list-style-type: none"> Adjust setpoint to desired cargo temperature and allow unit to run a minimum of 30 to 60 minutes (longer if possible) before loading cargo.
<p>Important: As product is being loaded, make sure evaporator air inlets and outlets are not blocked. Maximum air circulation is necessary to properly maintain the temperature of the entire load.</p>	

Inspecting the Load

Never assume that the product has been loaded properly. Watch for and perform the following tasks. It takes only a few minutes and could save you or your employer considerable time and money later on.

1. Turn the unit off before opening the cargo box doors to maintain efficient operation. Opening the doors while the unit is running allows warm air to enter the cargo box.

Note: The unit can be run with the doors open if the truck is backed into a refrigerated warehouse with tight loading dock door seals.

2. Perform a final check of the load temperature. If the load is too hot or too cold, make a final notation on the manifest.
3. While inspecting to see that the cargo is loaded properly, make sure the evaporator air inlets and outlets are not blocked.
4. Close or supervise the closing of the cargo compartment doors. Make

sure they are securely locked.

5. Check to make sure the unit setpoint is set at the desired temperature as listed on the manifest.
6. If the unit was stopped, restart using the appropriate starting procedure outlined in this manual.
7. Repeat the after-start inspection.
8. Defrost the unit 30 minutes after loading by starting a manual defrost cycle.

Enroute Inspections

Note: *Enroute inspections are recommended every four hours for the prevention of damage to the cargo.*

1. Note the setpoint to make certain no one has altered the setting since picking up the load.
2. Note the return air temperature reading. It should be within the desired temperature range. If the return air temperature reading is not within the desired temperature range, it indicates one of the following:
 - a. The unit has not had sufficient time to pull down the temperature. Refer to log, if possible, for history of load (for example, above temperature load, properly pre-cooled cargo compartment, length of time on road).
 - b. The unit is in defrost or has just completed defrost.

Note: *You can cancel defrost by turning the unit off, then restarting the unit.*

- c. The evaporator is plugged with frost. Initiate a manual defrost cycle. The defrost cycle will be automatically terminated.
- d. Improper air circulation within the cargo compartment. Inspect the cargo compartment (if possible) to determine if the evaporator fans are working and properly circulating the air. Poor air circulation can be due to improper loading of the cargo or shifting of the load, or the fan belt slipping
- e. The unit did not start automatically. If the unit cranked without starting, determine and correct the cause for not starting.
- f. The unit may have a low refrigerant charge. If liquid is not showing in the unit receiver tank sight glass, the refrigerant charge may be low. Adding refrigerant or repairing the refrigeration system requires a competent mechanic. Refer such problems to the nearest Thermo

Loading and Enroute Inspections

King dealer or authorized Service Center, or call the Thermo King Cold Line telephone number shown on the inside back cover of this manual for referral.

Note: *If the temperature in the compartment is not within the desired temperature range, repeat the Enroute Inspection every 30 minutes until the compartment temperature comes within the desired temperature range.*

Important: *Stop the unit if the compartment temperature remains outside the desired temperature range from the setpoint on two consecutive 30 minute inspections. Contact the nearest Thermo King Service Center or your company office immediately. Take all necessary steps to protect and maintain proper load temperature.*

3. Initiate a Manual Defrost cycle after each Enroute Inspection.

Specifications

Engine Specifications

Engine	T-1090 SPECTRUM: TK380F (Tier 4)
Fuel Type	Ultra low sulfur diesel (ULSD) fuel only [conforming to ASTM D975] No. 2 diesel fuel under normal conditions No. 1 diesel fuel is acceptable cold weather fuel
Oil Capacity	T-1090 SPECTRUM: 12.0 quarts (11.4 liters/litres) crankcase and oil filter T-1090 SPECTRUM: 13.0 quarts (12.3 liters/litres) w/Bypass Oil Filter - Fill to full mark on dipstick
Oil Type	API Classification CJ-4 or CK-4 ACEA Rating E6 Note: API Classification FA-4 oils are not approved for use and should not be used.
Oil Viscosity	14 F to 122 F (-10 C to 50 C): SAE 15W-40 (Synthetic) 5 to 104 F (-15 to 40 C): SAE 15W-40 5 to 104 F (-15 to 40 C): SAE 10W-30 (Synthetic or Synthetic Blend) -13 to 104 F (-25 to 40 C): SAE 10W-40 -13 to 86 F (-25 to 30 C): SAE 10W-30 -22 to 122 F (-30 to 50 C): SAE 5W-40 (Synthetic) Below -22 F (-30 C): SAE 0W-30 (Synthetic)
Cooling System Capacity	T-1090 SPECTRUM: 8.36 quarts (7.91 liters/litres)
Engine Coolant Type	Factory filled with Chevron Delo® XLC extended life coolant (ELC). 55/45 glycol/water concentration Freeze protection of -40°F/ -40°C Compatible coolants: Chevron Delo® XLC Havoline Delo® XLC (Europe) Caltex Delo® XLC (Asia) OR Meets the performance requirements of both ASTM D6210 and ASTM D3306 OAT extended life coolant, nitrite free

Specifications

<p>Important: Only OAT extended life coolants (Chevron Delo® XLC or equivalent) should be added to Thermo King systems. Conventional coolants should not be used (Typically identified by green or blue-green color). If a conventional coolant is combined with the Thermo King factory fill up to 25% by volume, the coolant must be changed at the next service opportunity. Above 25%, the coolant must be changed immediately. Conventional coolants dilute/interact with the additive packages of extended life coolant which significantly reduces the service life of the coolant.</p>	
Engine Thermostat	160 F (71 C)
Coolant Expansion Tank Cap Pressure	10 psig (69 kPa)

Refrigeration System

Contact your Thermo King dealer for refrigeration service or maintenance.

Electrical Control System Specifications

Control System Voltage	12.5 Vdc
Battery Charging System	12 volt, 37 amp, brush type, Thermo King Alternator
Voltage Regulator Setting	13.4 to 14.5 volts

Fuses

Fuse	Size	Function
F2	15A	Power to On/Off Switch
F3	40A	Fuel Sol Pull-In/Starter Circuit
F4	None	No Fuse
F5	40A	Preheat Circuit
F6	15A	Damper and High Speed Circuits
F7	2A	8XP Circuit - Controller On Feedback to HMI
F8	5A	2A Power to CAN Connector J12
F9	5A	2A Power to CAN Connector J14

Fuse	Size	Function
F10	10A	8X Power (Install fuse in right position)
F11	None	No Fuse
F12	5A	2A Power to CAN Connector J13
F13	2A	8FC Circuit (Remote Status Light/Optional Power)
F20	2A	Alternator Sense
F21	60A	Main Fuse (2 Circuit)
F25	7.5A	HPCO Switch Circuit
F26	5A	Power to CAN Connector J98

F10 When fuse F10 is installed in the right position the On/Off keys on the HMI turn the unit on and off. When fuse F10 is installed in the left position the unit will start and run without the HMI controller.

Electric Standby Specifications (SmartPower™ Model 50 Units)

Electric Motor and Overload Relay

T-1090 and T-1090 SPECTRUM

Voltage/ Phase/ Frequency	Horse- power	Kilowatts	RPM	Full Load (amps)	Overload Relay Setting (amps)
230/3/50	10.0	7.5	1460	25.3	38
200-230/3/60	12.0	8.9	1750	28.8	38
400/3/50	10.0	7.5	1460	13.90	19
460/3/60	12.0	8.9	1750	14.4	19

Specifications

Standby Power Requirements

Standby Power cord to remote receptacle	Power plug rating	Power Supply circuit breaker	Plug configuration	Plug type
12/9HP Motor (T-1090 SPECTRUM)	230 V 50A	50 A	CS8364	Twistlock

Unit Maintenance

A regular inspection and maintenance program will help to keep your unit in top operating condition. While pre-trip inspections can be performed by the operator (e.g., checking oil and coolant levels), all major and minor service requirements should be handled by a Thermo King dealer for four very important reasons:

- They are equipped with the factory recommended tools to perform all service functions
- They have factory trained and certified technicians
- They have genuine Thermo King replacement parts
- The warranty on your new unit is valid only when the repair and replacement of component parts is performed by an authorized Thermo King dealer

After the first week of operation:

- Retighten unit mounting bolts
- Check belt tension
- Check coolant level
- Check engine oil level
- Check refrigerant level
- Check refrigerant oil level

The following general maintenance inspection schedule is provided to assist in monitoring that maintenance.

Maintenance Inspection Schedule

Remote Evaporators

Pretrip	1,200 Hours	Annual/ 3,000 Hours	Inspect/Service These Items	Completed
Electrical				
	•	•	Inspect wire harness for damaged wires or connections.	
		•	Inspect/replace DC fan motors.	
Structural				
•	•	•	Visually inspect unit for fluid leaks.	
•	•		Visually inspect unit for damaged, loose or broken parts.	
	•	•	Clean entire unit including evaporator coils and defrost drains.	
		•	Check all mounting bolts, brackets, lines, hoses, etc.	

Serial Number Locations

The serial number of your unit, the engine, or the compressor may be required when contacting a Thermo Dealer or the Emergency Cold Line service. Record these numbers for quick access when needed.

Figure 54. Engine Serial Number Location Shown (All Models)

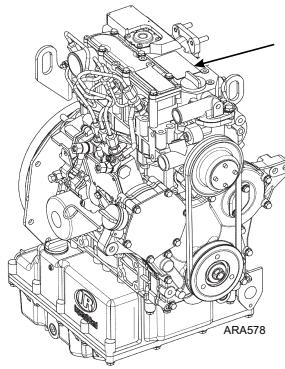
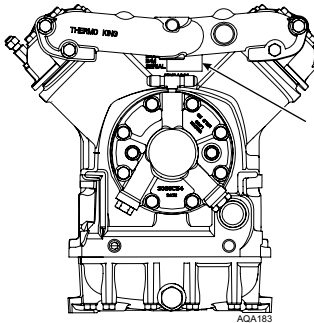
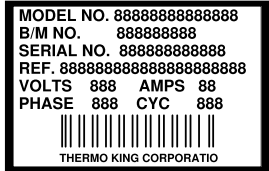
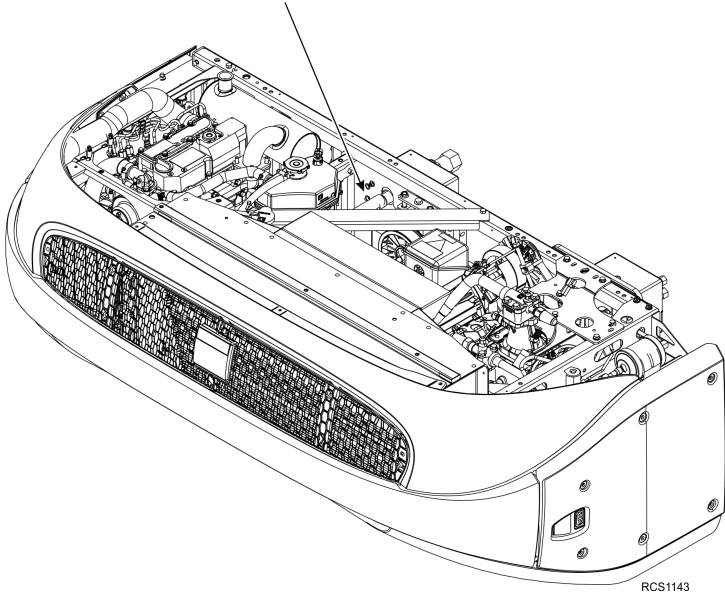

Figure 55. X430P Compressor Serial Number Location Shown



Serial Number Locations

Figure 56. Unit Serial Number Plate Located on Frame



AQA011

**Figure 57. Serial Number Plate Location
(S-3 shown, S-2 similar)**



1.	Serial nameplate on right end of evaporator frame behind cover
----	--

1.	Serial nameplate on right end of evaporator frame behind cover
----	--

Emergency Cold Line



RCS358

Unit Warranty

Please contact your nearest Thermo King dealer for terms of the Thermo King North American Self Powered Truck Unit Limited Warranty.

EPA and ARB Supplemental Emissions Warranty Statement

Your Thermo King unit is covered by the diesel engine manufacturer's EPA and ARB Supplemental Emissions Warranty. Complete details of this emission warranty can be found at www.thermoking.com.

Thermo King – by Trane Technologies (NYSE: TT), a global climate innovator – is a worldwide leader in sustainable transport temperature control solutions. Thermo King has been providing transport temperature control solutions for a variety of applications, including trailers, truck bodies, buses, air, shipboard containers and railway cars since 1938. For more information, visit www.thermoking.com or www.tranetechnologies.com.

Thermo King has a policy of continuous product and product data improvements and reserves the right to change design and specifications without notice. We are committed to using environmentally conscious print practices.